



X26E Electro-Muscular Disruptor





Video



TERMINAL LEARNING OBJECTIVE

Without the aid of references, given an X26E, air cartridges, appropriate training environment, adequate instruction and practical exercises; employ the X26E Electro-Muscular Disruptor (EMD), demonstrating required knowledge and skill IAW this lesson plan, applicable laws, Service policy, regulation, ROE / use of force, and unit SOP.



ENABLING LEARNING OBJECTIVES

- 1. State the X26E's intended purpose and function as a nonlethal electro-muscular disruption weapon.**
- 2. Identify X26E nomenclature, parts and functions.**
- 3. Identify X26E air cartridges and their characteristics.**
- 4. Perform a functions check on X26E.**



ENABLING LEARNING OBJECTIVES

continued

5. Load and unload X26E.
6. Conduct Preventive Maintenance, Checks and Services.
7. State applicable law, Service policy, regulation, order, instruction, directive regarding the use and employment of X26E.
8. Download X26E usage data. (Unit SOP dependent)
9. Engage targets with X26E.

METHOD/MEDIA. This training will be taught by lecture, demonstration and practical application methods, (with the aid of Power Point presentation) and X26Es with air cartridges and targets.

INSTRUCTOR NOTE: *The INIWIC instructor must be fully capable and prepared to conduct this instruction and training in a field, deployed or operational environment without the benefit of a classroom or Power Point presentation.*

Evaluation. You will be administered a qualification performance evaluation at the end of this period of instruction.

INSTRUCTOR NOTE: *Requiring a written test as a part of unit qualification for the X26E is optional. This lesson plan sets minimum acceptable standards. Based on the INIWIC instructor's assessment, mission and/or unit senior leadership guidance, qualification criteria may be raised at the unit level, but it SHOULD NOT be lowered.*

INIWIC COURSE – NOT FOR USER / UNIT TRAINING



SAFETY BRIEF. The INIWIC instructor is required to write their own Service-unique ORM/risk assessment for this training as a graduation requirement. A safety brief, similar to a weapons qualification range safety brief must be given.

Insert OUR ORM

INIWIC COURSE – NOT FOR USER / UNIT TRAINING



Insert OUR ORM



State the X26E's intended purpose and function as a nonlethal electro-muscular disruption weapon

Department of Defense Directive 3000.3

Subject: Policy for Nonlethal Weapons

Nonlethal Weapons ... are explicitly designed and primarily employed so as to incapacitate personnel or materiel, while minimizing fatalities and permanent injury to personnel. Nonlethal weapons are intended to have relatively reversible effects on personnel or materiel.



State the X26E's intended purpose and function as a nonlethal electro-muscular disruption weapon

Policy for Nonlethal Weapons, continued

Nonlethal weapons shall not be required to have a zero probability of producing fatalities or permanent injuries.

However, while complete avoidance of these effects is not guaranteed or expected, when properly employed, nonlethal weapons should significantly reduce them as compared with physically destroying the same target.



State the X26E's intended purpose and function as a nonlethal electro-muscular disruption weapon

Policy for Nonlethal Weapons, continued

Nonlethal weapons may be used in conjunction with lethal weapon systems to enhance the latter's effectiveness and efficiency in military operations.

This shall apply across the range of military operations to include those situations where overwhelming force is employed.



State the X26E's intended purpose and function as a nonlethal electro-muscular disruption weapon

**EMD (Electro-Muscular Disruption) weapons
stun and override
the central nervous system
causing uncontrollable contractions
of the muscle tissue.**

**A subject exposed to EMD loses control of his
body, cannot perform coordinated action,
and usually falls to the ground**



State the X26E's intended purpose and function as a nonlethal electro-muscular disruption weapon

The X26E, Electro-Muscular Disruptor (EMD)

- commercial-off-the-shelf nonlethal weapon**
- fires two barbed projectiles (probes) into a target**
- with the purpose of delivering electrical energy**
- to subdue the target without harm to the target or the operator**



State the X26E's intended purpose and function as a nonlethal electro-muscular disruption weapon

- Operated much like a standard issue sidearm complete with a laser sight**
- When the trigger is pulled the two barbs are propelled by compressed nitrogen cartridges**
- The barbs are connected to the weapon by insulated wires and are effective within two inches of the subject's body (the electrical charge can penetrate up to two inches of cumulative clothing)**



X26E Firing

When the circuit is completed (both barbs hit the target), a 5-second cycle of electrical pulses begins and sent through the wires into the target

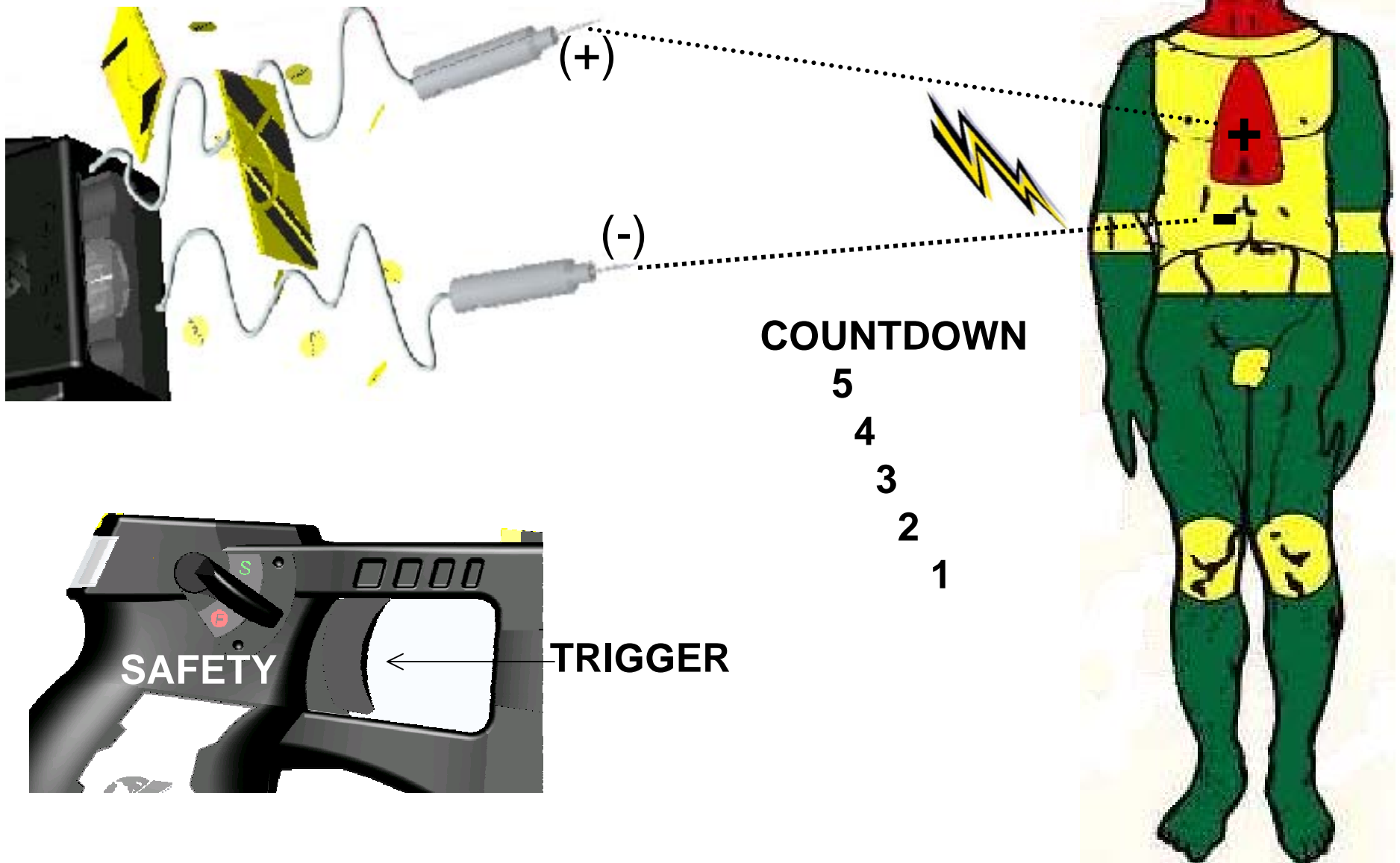

The cycle can be stopped by moving the safety lever down or can be restarted by pulling the trigger again

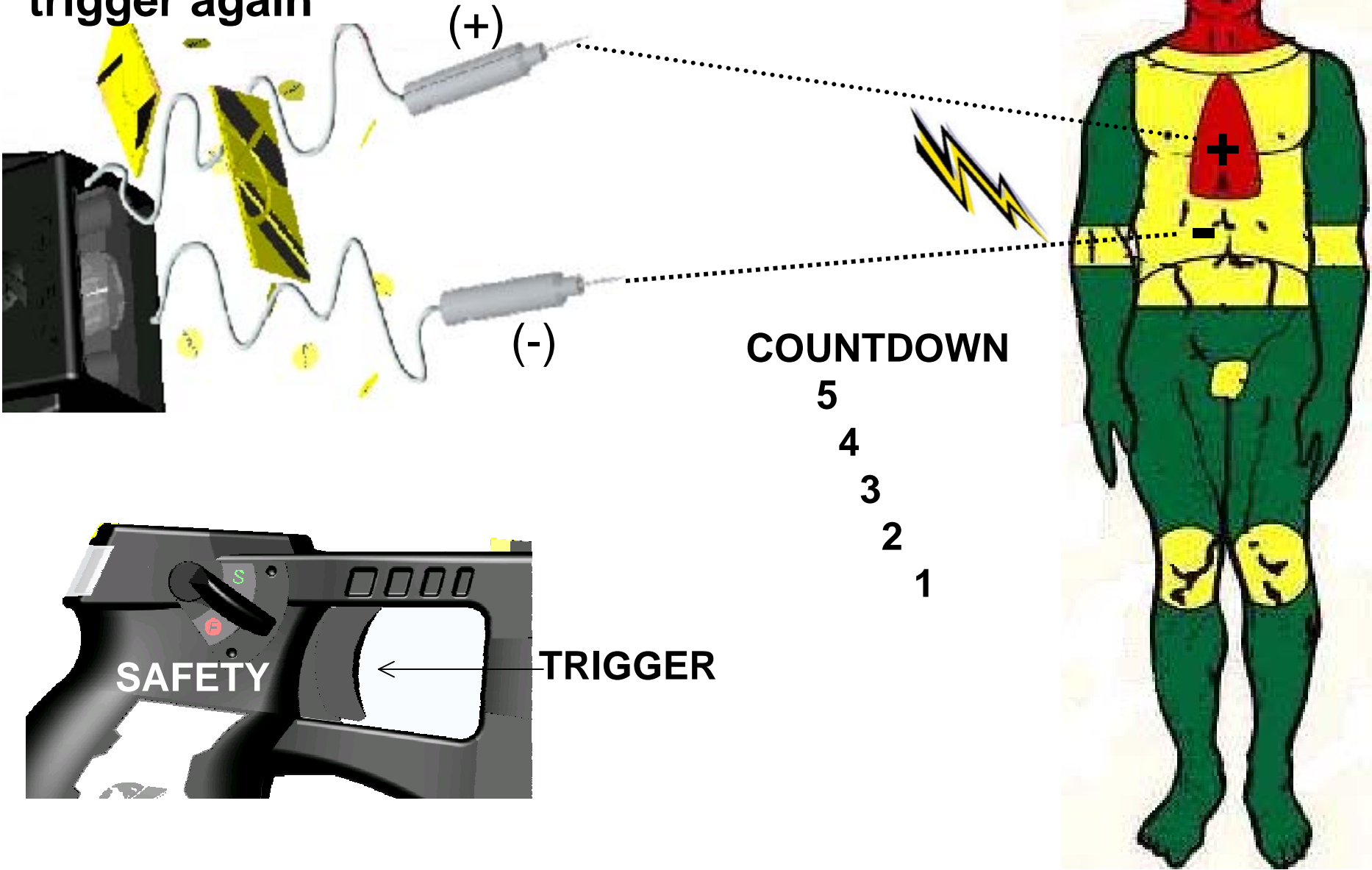

X26E sends electrical signals similar to those used by the brain to communicate with the body. The signals overpower the normal electrical signals within the body's nerve fibers

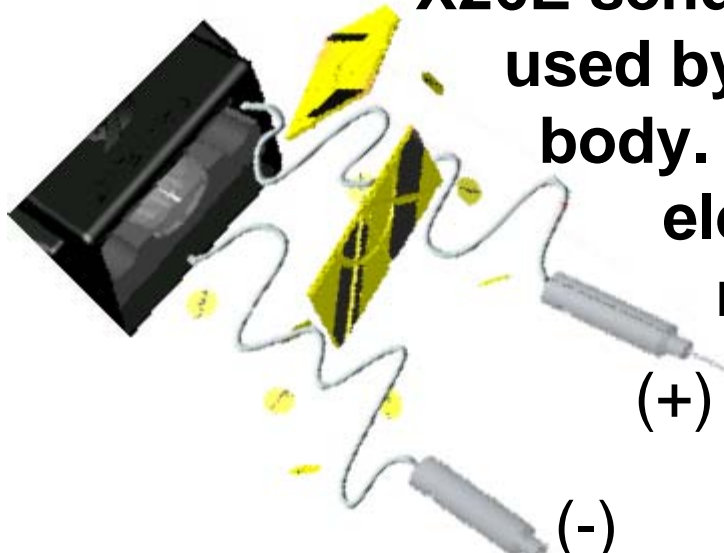

The targeted subject loses control of his body, may not be capable of coordinated action, and usually falls to the ground

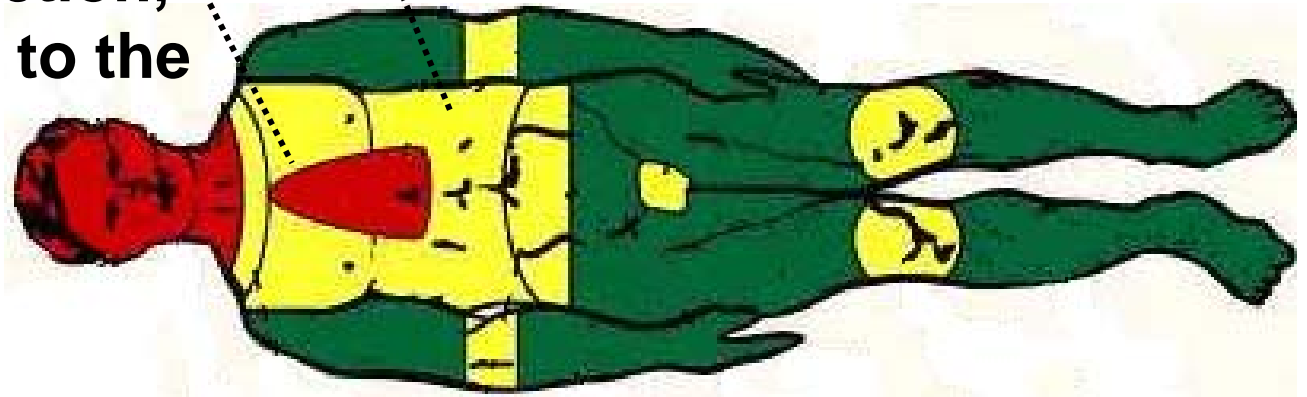
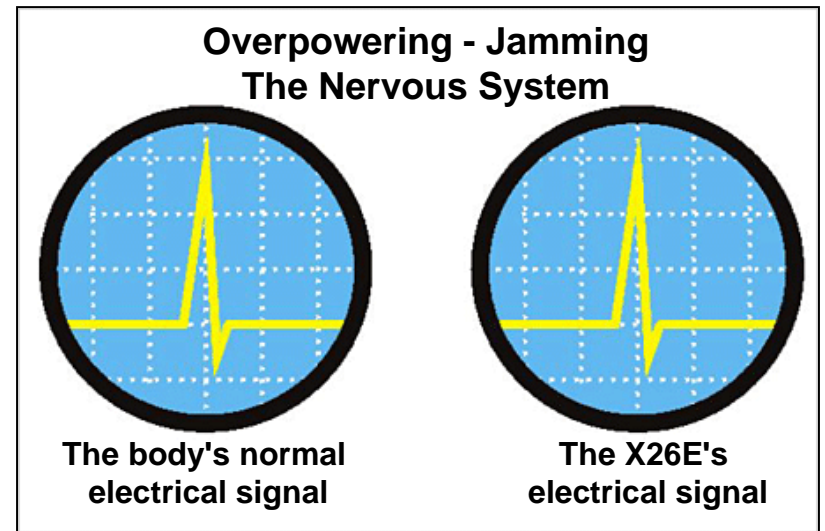

The X26E sends out short duration, high voltage electrical waves that overpowers the normal electrical signals within the nerve fibers. These waves create extra “noise” within the nervous system much like static on the “phone lines” of the human body.

Stun weapons jam the central nervous system with electrical noise. This only affects the sensory nervous system creating pain compliance. The X26E can function as a stun weapon when used in the “drive stun” mode – the contacts placed directly in contact with the target.

The X26E does not rely on pain to achieve compliance, but instead, overwhelms the central nervous system to achieve incapacitation.

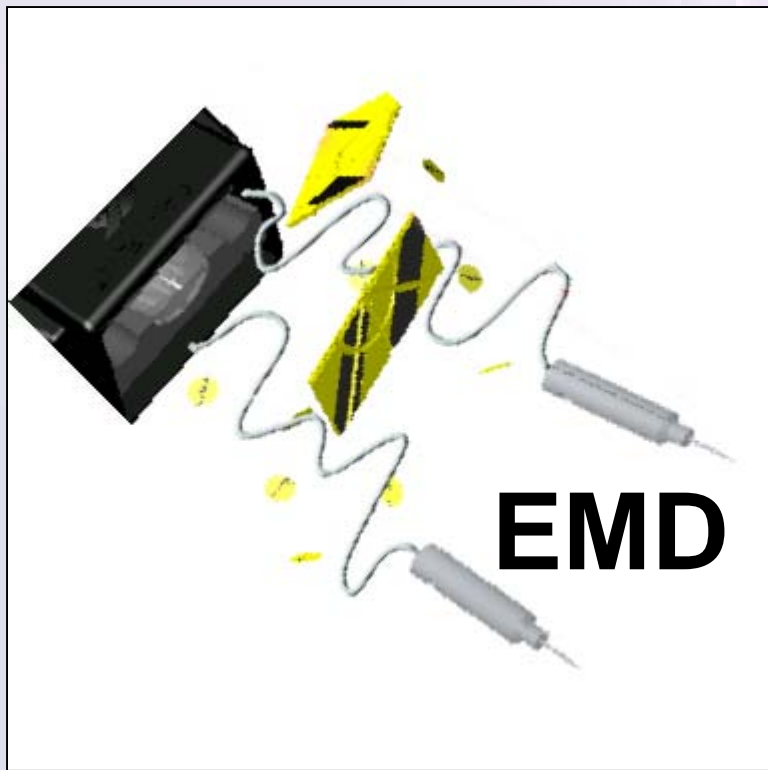



An electrical current of less than **0.02 amps** can produce sensations ranging from tingling to sharp pain

A more serious effect occurs if the current causes muscles to contract. A person touching a live wire with their outstretched hand may literally not be able to let go of the wire due to the current's effect on the muscles

Currents from **0.03 to 0.07 amps** will begin to impair the ability of the person to breathe

The X26E delivers **0.0021 amps**





Amperes: Total electrons per second (0.0021 amps)

Volts: “Pressure” pushing electrons (50,000 volts)

Typically, we experience 35,000 to 100,000 volts in our daily lives with "static electricity", when a spark jumps to us - door knobs, each other, etc.

The DANGER is the AMPS not the volts

One probe can arc through 2 cumulative inches of clothing or 1 inch of clothing per probe

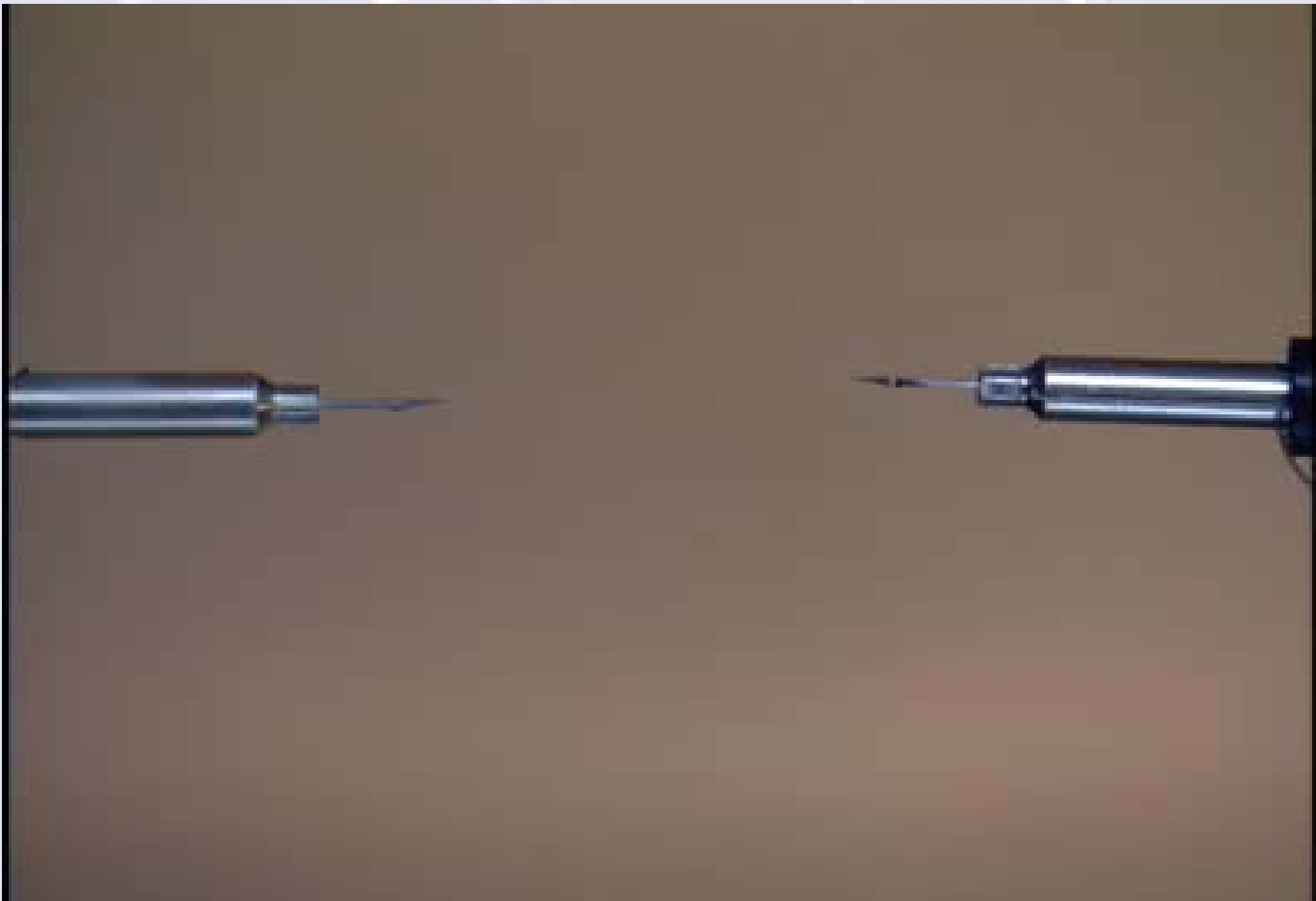

It is the high voltage that makes penetration possible

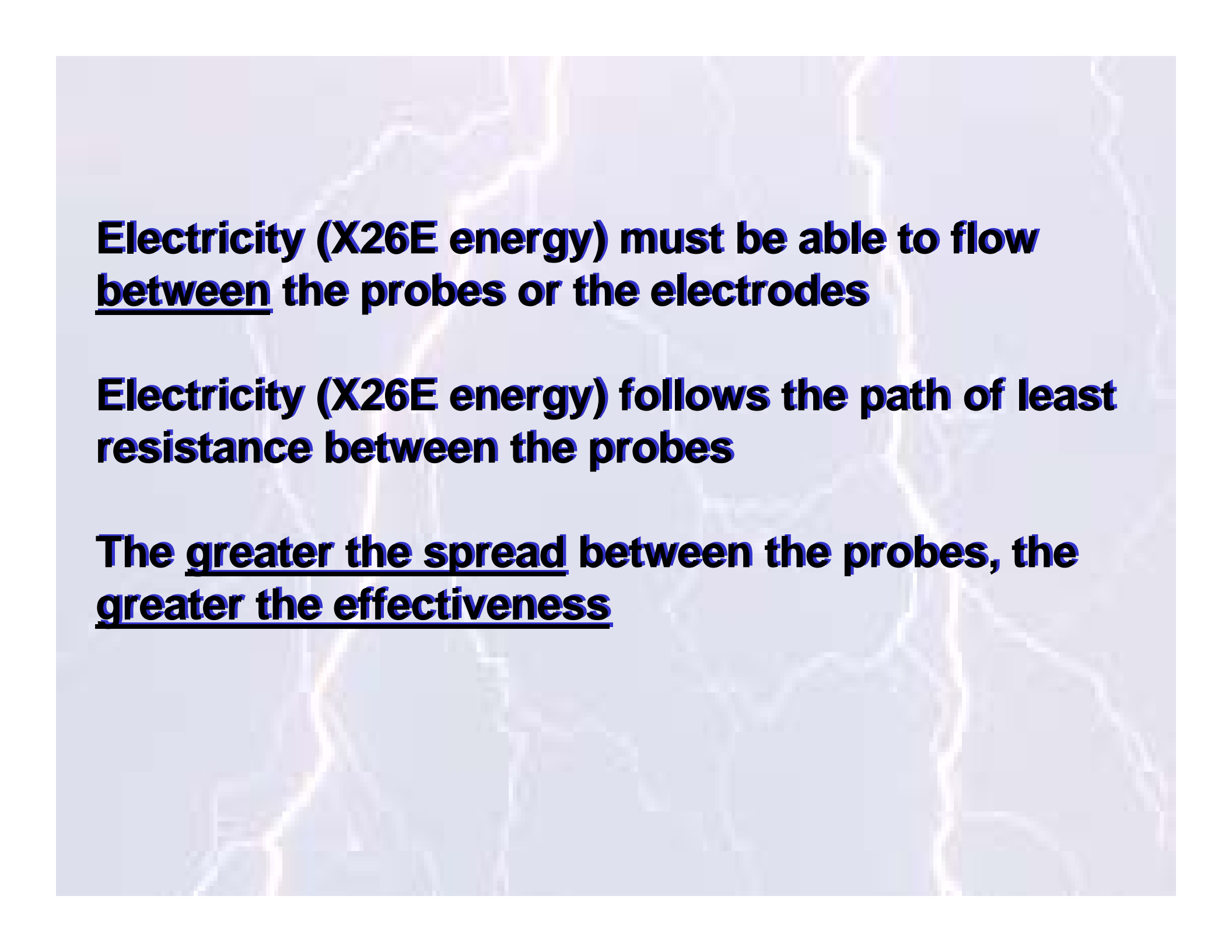
The background of the slide features a faint, repeating pattern of lightning bolts in a light blue or grey color, set against a slightly darker blue background. The bolts are jagged and branch out, creating a sense of energy and movement.

Electricity (X26E energy) must be able to flow between the probes or the electrodes

Electricity (X26E energy) follows the path of least resistance between the probes

The greater the spread between the probes, the greater the effectiveness

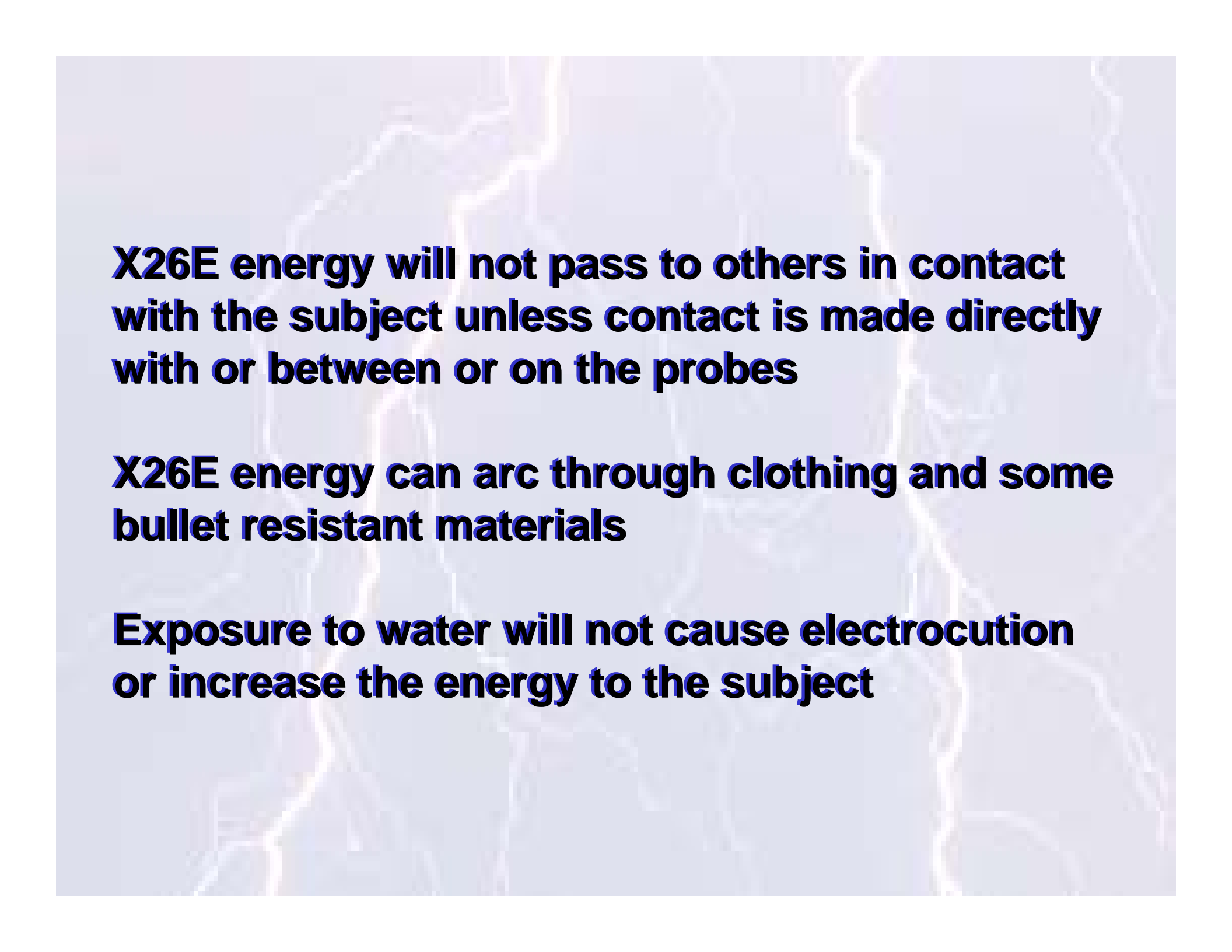
The background of the slide features a stylized, glowing blue and white lightning bolt striking down from the top center, with several smaller, fainter bolts branching out from the main one. The overall color scheme is a light, hazy blue.

X26E energy will not pass to others in contact with the subject unless contact is made directly with or between or on the probes

X26E energy can arc through clothing and some bullet resistant materials

Exposure to water will not cause electrocution or increase the energy to the subject

Common Effects of X26E EMD



- Subject can fall immediately to the ground
- Yell or scream
- Involuntary muscle contractions
- Subject may freeze in place with legs locked
- Subject may feel dazed for several seconds/minutes
- Potential vertigo
- Temporary tingling sensation
- May experience critical stress amnesia
(May not remember any pain)

Probable X26E Risks and Side Effects

- Can cause signature marks that resemble minor surface burns - appear red or may blister
- Probe(s) can cause eye injury
- Can ignite flammable liquids or gases
- Can cause strong muscle contractions
 - Exertion is similar to athletic activities such as weight lifting or wrestling and may result in similar type injuries such as muscle or tendon strain or tear, joint injuries, back injuries, stress fractures or other secondary injuries resulting from strong muscle contraction.
 - Muscle contractions may pose additional risk to certain persons such as pregnant women
- Can cause secondary injuries from person falling
 - Fall injuries, particularly from elevated heights, can pose risk of significant injury or death
- Can cause pain and associated stress

What X26E EMD does not do:

- **Does not damage nerve tissue**
- **Does not cause “electrocution” in a wet environment**
- **Generally does not cause urination or defecation**

Drive Stun Scarring





Identify X26E nomenclature, parts and functions



Identify X26E nomenclature, parts and functions





Identify X26E nomenclature, parts and functions

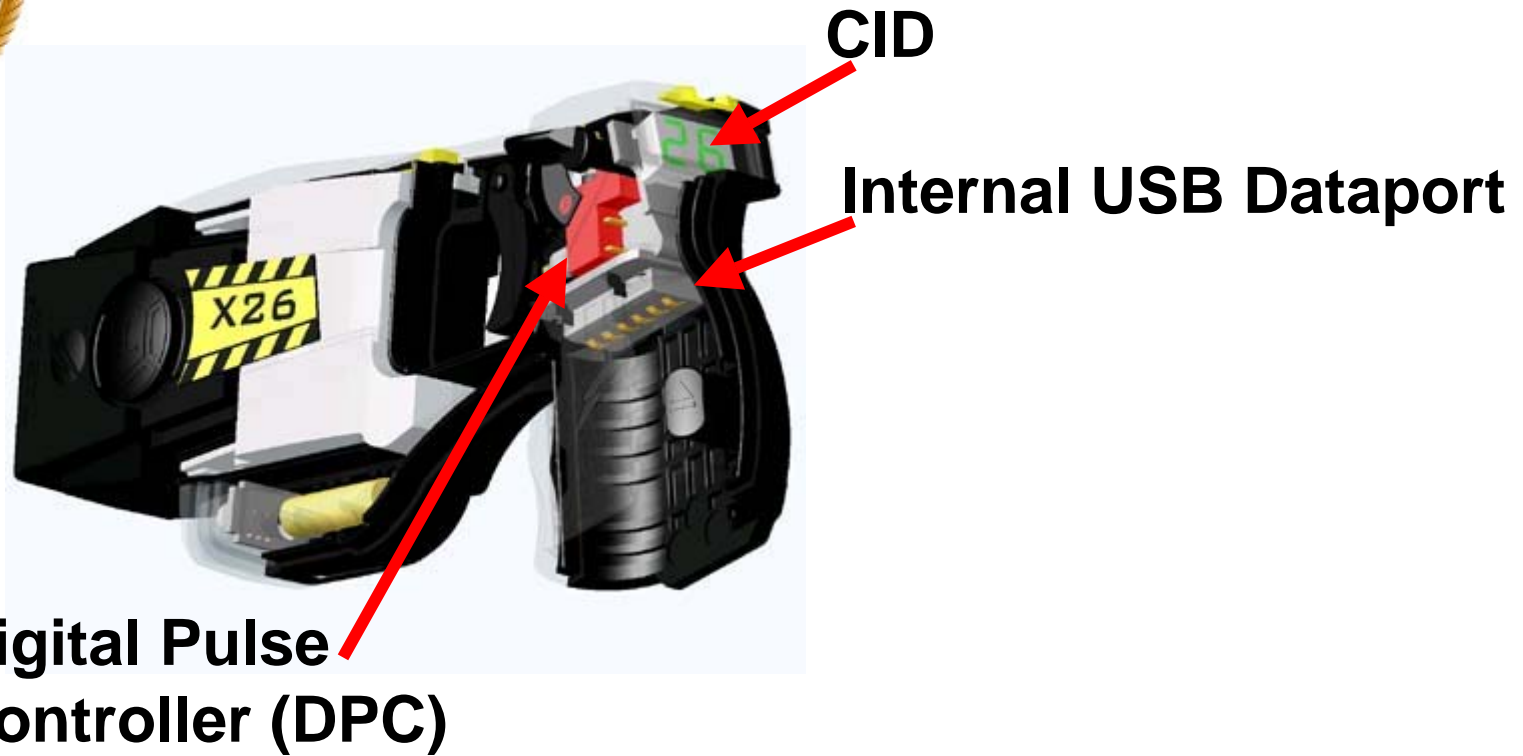

The Digital Pulse Controller (DPC) is an internal circuit including the microprocessor of the X26E and various support hardware. When fired, the DPC measures the time between each energy pulse discharged from the weapon. The DPC then regulates the power throughput of the pulse generator to maintain a constant pulse rate. All pulse rates are approximate and may vary slightly.



Identify X26E nomenclature, parts and functions

Central Information Display (CID) indicates:

- Digital Power module (DPM) power level
- Burst time countdown
- Warranty/general systems status
- Re-arm required status ○ ○ ● ●
- Illumination Setting

CENTRAL INFORMATION DISPLAY (CID):

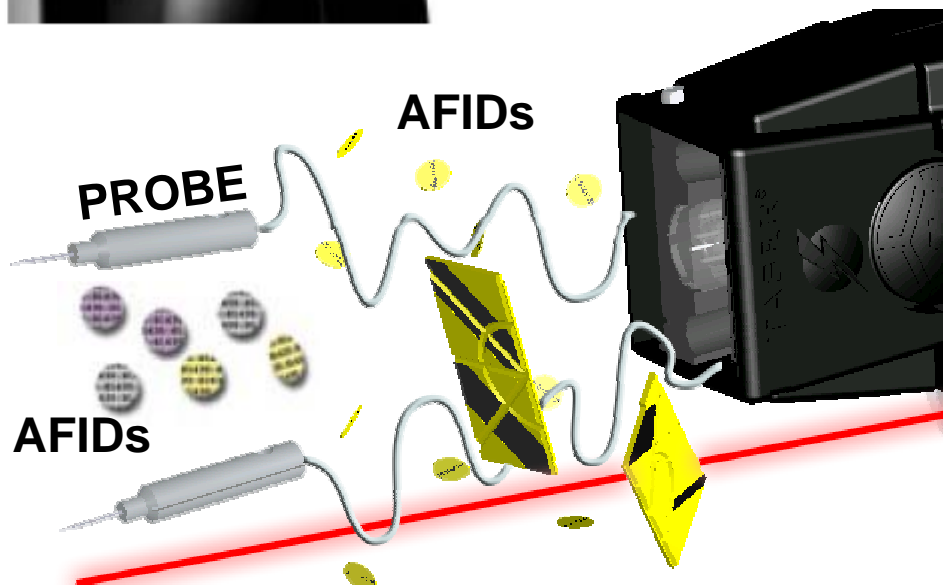

Air cartridges contain at least forty Anti-Felon Identification (AFIDs) tags which are ejected when the device is fired



Identify X26E nomenclature, parts and functions

Central Information Display (CID)

- **0-99% battery level**
 - Safety up
- **5,4,3,2,1 countdown**
 - Triggered
- **Illumination status**
 - Light selector button
- **System diagnostics**
 - When DPM is Loaded
 1. Warranty expiration date: YR, MO & Day flash
 2. Current date & time: YR, MO, Day, 24 HR & MN flash
 3. Current Celsius internal temperature
 4. Software revision level





Identify X26E nomenclature, parts and functions

- SAFE & unloaded
- Press selector & hold for 1 second
- Press and release to toggle modes:
 - **LO**: Laser Only will illuminate
 - **OF**: Only Flashlight will illuminate
 - **LF**: Laser and Flashlight both illuminate
 - **OO**: Off and Off neither laser nor light will illuminate and the CID goes dim

Illumination Selector

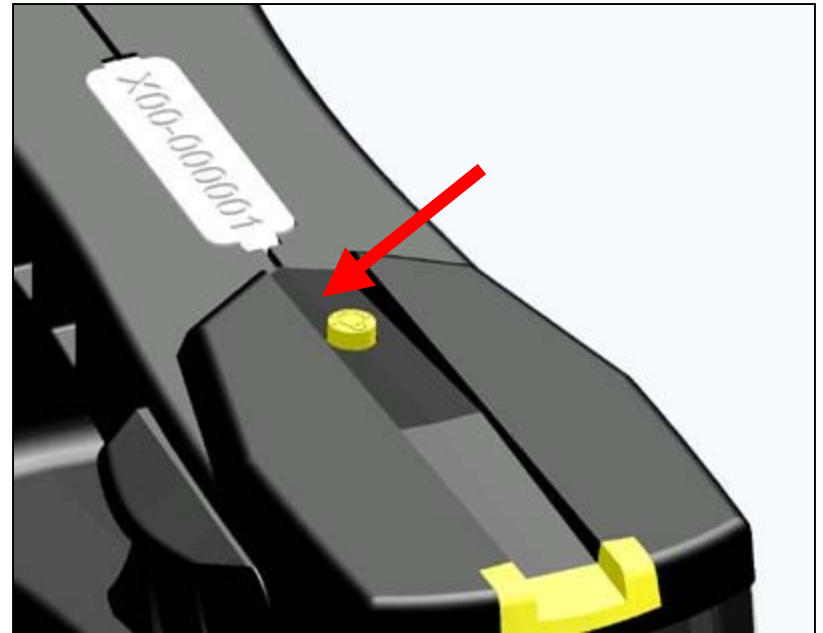



Identify X26E nomenclature, parts and functions

Digital Power Magazine

- 10-year shelf life
- Lithium energy cells
- Provides up to 300 cycles (pre version 15)
- Provides up to 195 cycles (version 15+)
- Digital memory (% life)
- DPM must be left in the weapon at all times to maintain system clock

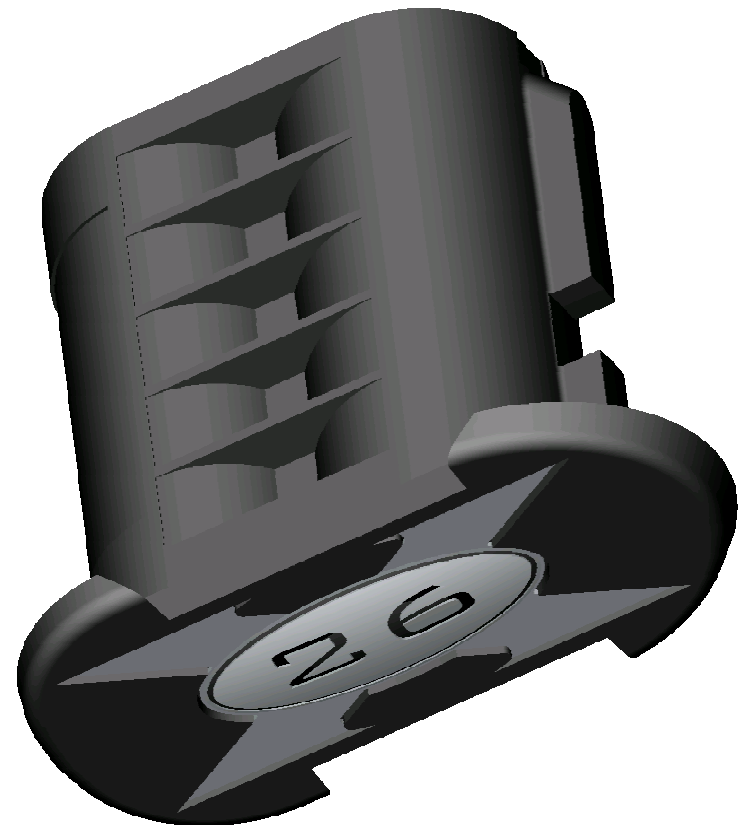



CAUTION - WARNING



**This exercise will be performed WITHOUT a CARTRIDGE
WITH or WITHOUT A CARTRIDGE the X26E will "FIRE" its
electrical energy if the safety is off and the trigger
is pulled, it will cycle, spark and expose YOU to unintended
Electro-Muscular Disruption and/or Stun Effect IF YOU DO
NOT HANDLE IT PROPERLY - KEEP HANDS, FINGERS &
ANY OTHER PARTS OF YOUR BODY AWAY FROM THE
CONTACTS WHEN THE SAFETY IS OFF OR WHEN THE
X26E IS DISCHARGING**



CAUTION - WARNING



DO NOT POINT THE X26E AT OTHERS DURING THIS EXERCISE. KEEP X26E POINTED IN SAFE DIRECTION.

DO NOT SHINE THE X26E's LASER AT THE EYES OF OTHERS DURING TRAINING.

FAILURE TO FOLLOW SIMPLE INSTRUCTIONS AND A DEMONSTRATED LACK OF DISCIPLINE HERE IS CAUSE TO ELIMINATE THE OFFENDING SERVICEMEMBER FROM X26E TRAINING, RENDERING THEM UNQUALIFIED FOR ISSUE, CARRY OR USE OF THE X26E.



PRACTICAL EXERCISE - I

- **WAIT FOR INSTRUCTIONS**
- **SAFETY DOWN & no air cartridge present**
- **When INSTRUCTOR TELLS YOU:**
 - **Press selector & hold for 1 second w/ fingernail or pen**
 - **Press and release to toggle to:**
 1. **LO: Laser Only will illuminate (wait)**
 2. **OF: Only Flashlight will illuminate (wait)**
 3. **LF: Laser and Flashlight both illuminate (wait)**
 4. **OO: Off and Off neither laser nor light will illuminate and the CID goes dim (wait)**

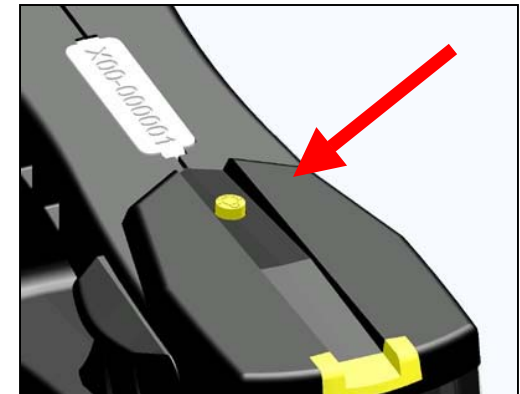

PRACTICAL EXERCISE - II

- “SAFE” & unload cartridge
- Remove & reload DPM

Code sequence

- Warranty expiration
 - Prior to first trigger activation, warranty field information flashes rapidly
 - After first trigger pull, warranty information shows current date plus one year: YY, MM, DD
- “--” Separator
- Current system time (**GMT**)
 - YY, MM, DD, HH, MM
- “--” Separator
- System temperature
 - -99 to + 99 Celsius
 - Flashing number is negative
- Software revision number



Write Down Displayed Data

Warranty: Standard warranty is 1-year from first trigger pull. One and four year extended warranties are available.



Identify X26E nomenclature, parts and functions

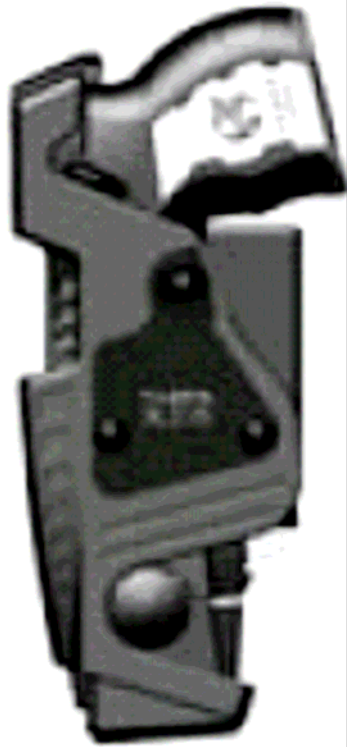

The X26E ships with a holster. The holster is ambidextrous and can be reconfigured for left-hand carry in a matter of minutes with an included hex key.

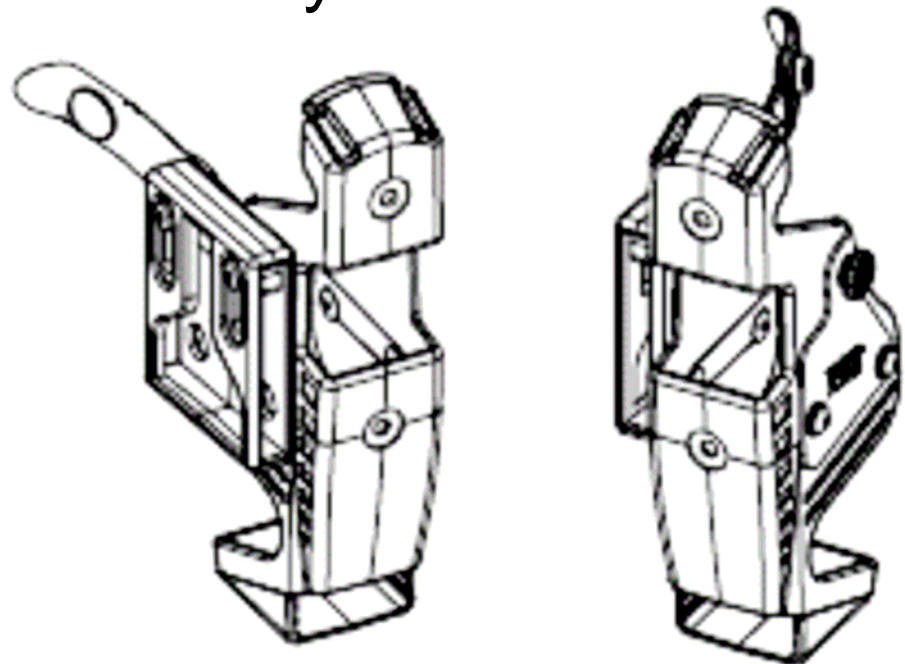



The X26E attached to the Picatinny rail of an M4 rifle by means of the **X-Rail assembly**



Identify X26E air cartridges and their characteristics



Identify X26E air cartridges and their characteristics



15 ft.

(4.6 meters)

Solid Yellow Door

Live Cartridge
Regular Probe



21 ft.

(6.4 meters)

Striped Door

Live Cartridge
Regular Probe

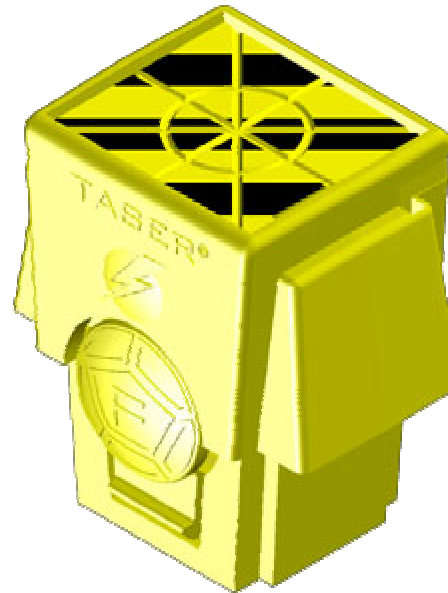

XP 21 ft.

(6.4 meters)

Yellow Cartridge

Live Cartridge
XP Probe
Longer, Heavier

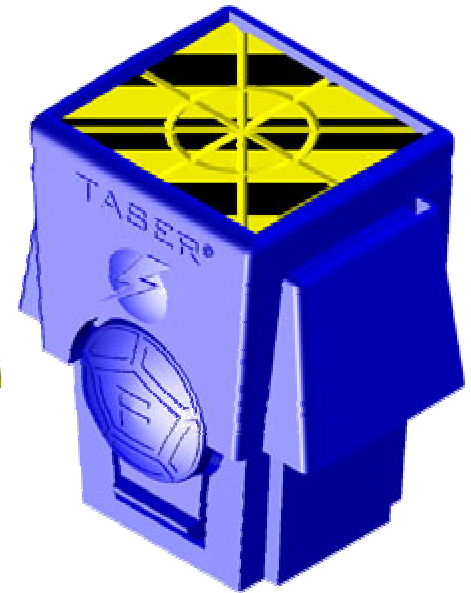

LS 21 ft.

(6.4 meters)

Blue Cartridge

Live Simulation
Short Probe Non-
Conductive Wire.
Stun portion works!



Identify X26E air cartridges and their characteristics

Cartridge Changes



21 ft.
(6.4 meters)
Striped Door

Live Cartridge
Regular Probe
Before August 2004



21 ft.
(6.4 meters)
Silver Door

Live Cartridge
Regular Probe
After August 2004





Identify X26E air cartridges and their characteristics

Cartridge Changes

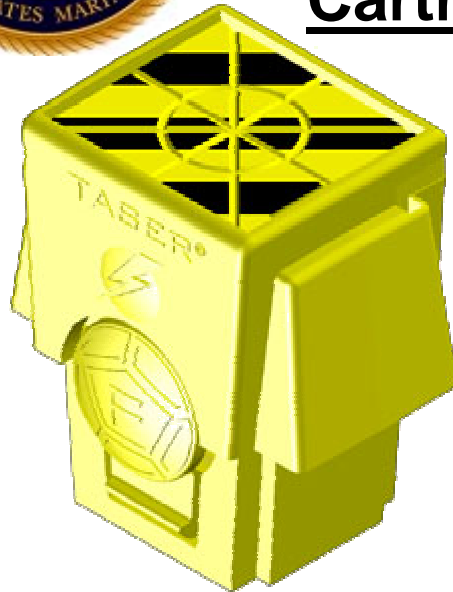

XP 21 ft.
(6.4 meters)
Yellow Cartridge

Live Cartridge
XP Probe
Longer, Heavier
Before October 2004



Hybrid XP 25 ft.
(7.6 meters)
Green Door

Live Cartridge
XP Probe
Heavier
After October 2004





Identify X26E air cartridges and their characteristics

Cartridge Changes

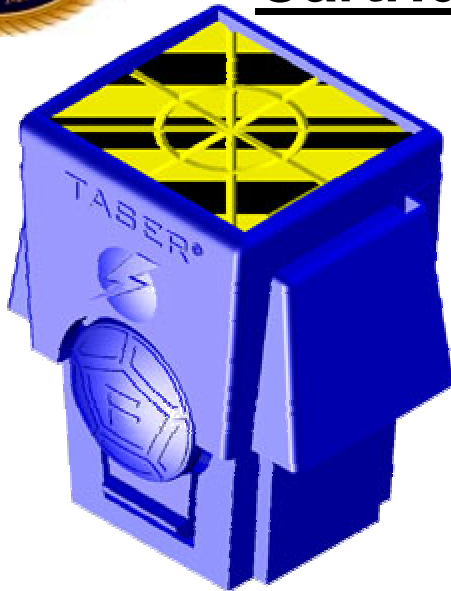

LS 21 ft.
(6.4 meters)
Blue Cartridge
Striped Doors
Live Simulation
Short Probe
Non-Conductive Wire.
Stun portion works!



LS 21 ft.
(6.4 meters)
Blue Cartridge
Blue Door
Live Simulation
Short Probe
Non-Conductive Wire
Stun Portion Works!



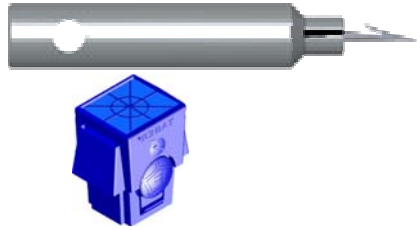
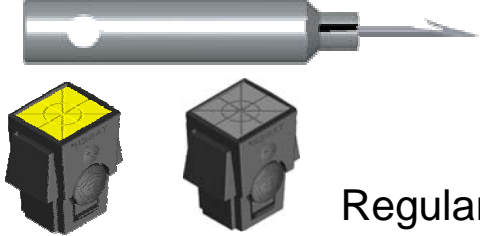
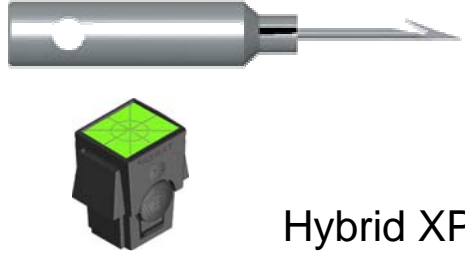

Identify X26E air cartridges and their characteristics

PROBES	Mass (g)	Needle Length	Speed	Energy Kg(m/s) ²
 <p>LS</p>	1.6g	.20" 0.50 cm	166 fps to 98 fps	2.0 to 0.7
 <p>Regular</p>	1.6g	0.35" 0.89 cm	166 fps to 98 fps	2.0 to 0.7
 <p>Hybrid XP</p>	2.6g	0.52" 1.32 cm	179 fps to 96 fps	3.89 To 1.12

Top figures @ muzzle

Bottom figures @ 13 feet



Identify X26E air cartridges and their characteristics

Propulsion System 15 and 21 foot cartridges

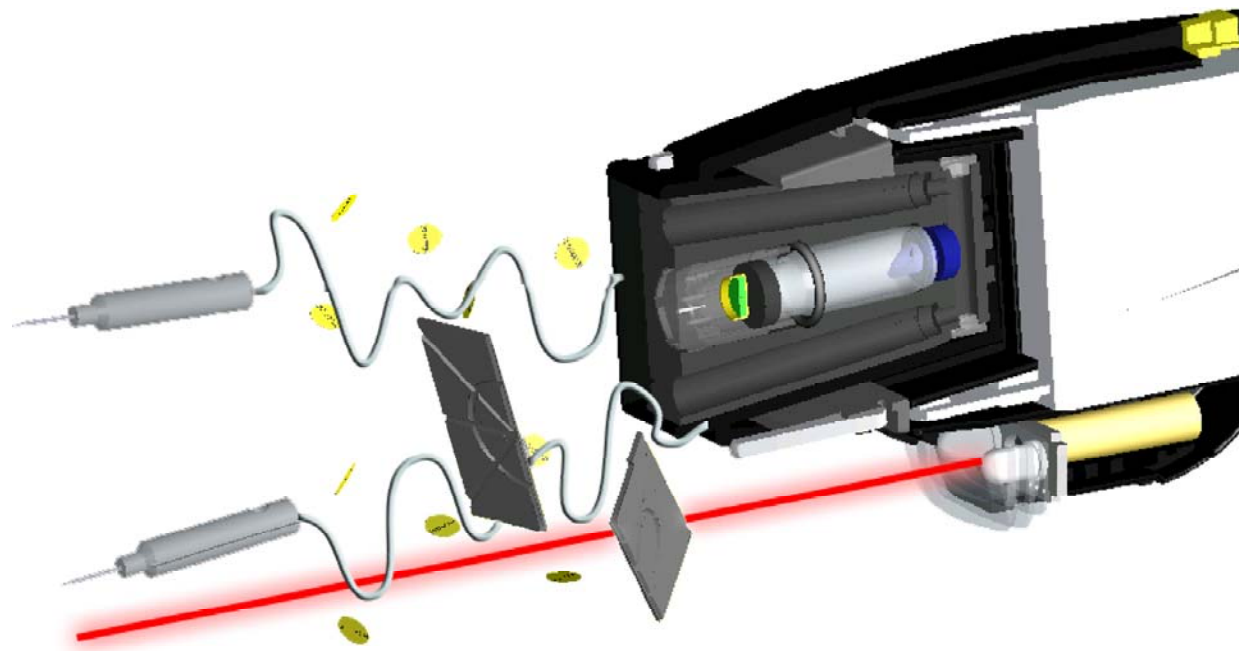

- 1,800 PSI nonflammable nitrogen capsule
- 2 probes fired at 160+ feet per second
- Maximum range: 15 feet or 21 feet



Identify X26E air cartridges and their characteristics

Propulsion System 25 foot Cartridge

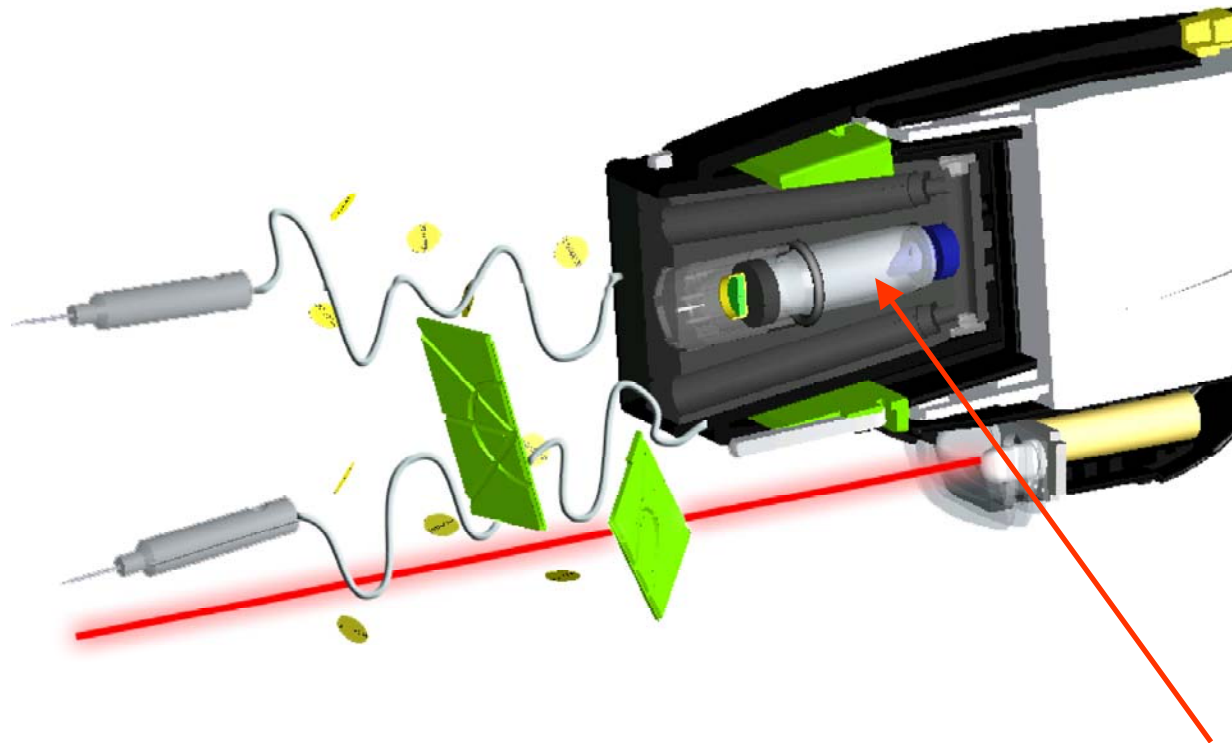

- 2,200 PSI nonflammable nitrogen capsule
- 2 probes fired at 179+ feet per second
- Maximum range: 25 feet



Identify X26E air cartridges and their characteristics

- **Wires are thin and have an insulated coating**
- **Wires can break easily if stepped on or pulled**
- **Inadvertent contact with wires or the probe during discharge can result in electrical shock**
- **The X26E operator must advise Servicemembers officers to avoid wires during restraint for wire integrity**



AFIDs

WIRES

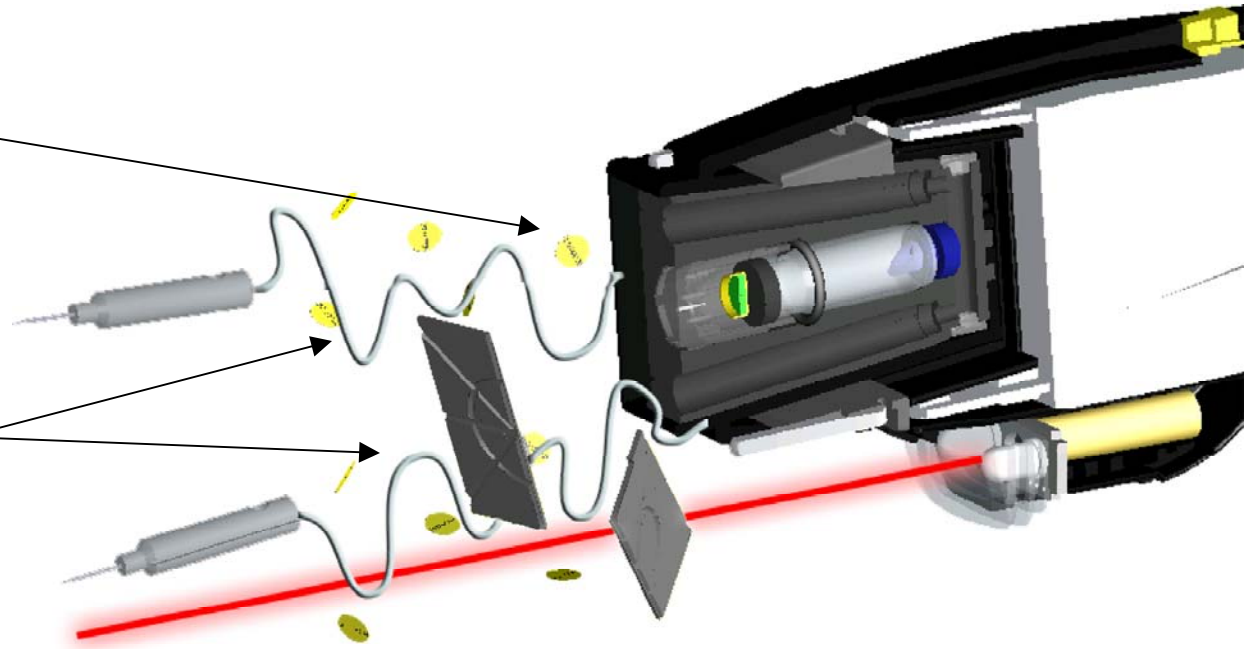

**Two wires, 15+ feet of wires
between you and the target...**

**Don't get yourself or allows
Others to get themselves tangled
up in them**



Identify X26E air cartridges and their characteristics

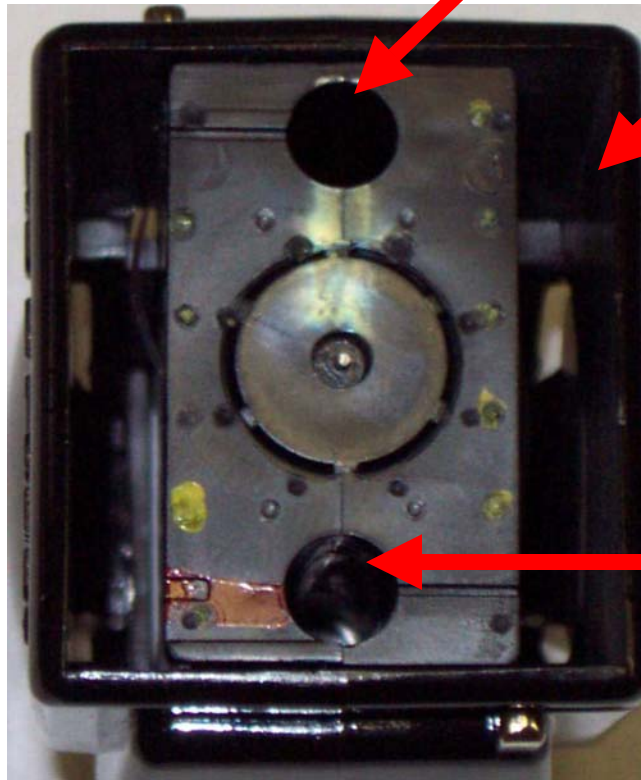

**Blast Doors Present
UNEXPENDED**

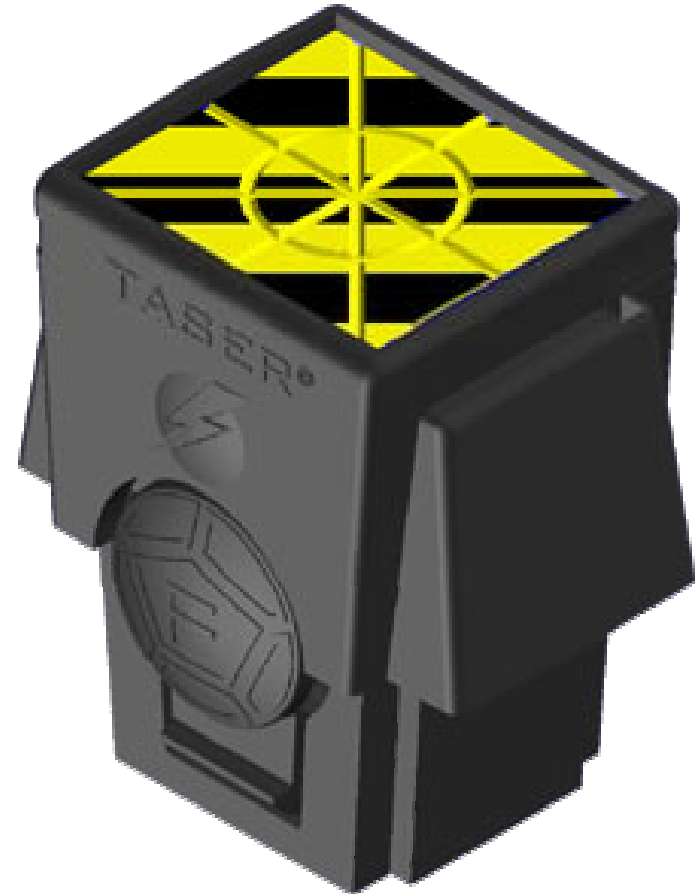

**EXPENDED AIR CARTRIDGE
No Blast Doors/Probes/Wires**



Perform a Functions Check on X26E



Perform a Functions Check on X26E



X26E Functions Check:

- Ensures that the X26E is fully operational
- Conditions components for regular use
- Conduct a functions check prior to each mission (pre-execution/inspection)
- Functions check (spark) should not last longer than one second



CAUTION - WARNING

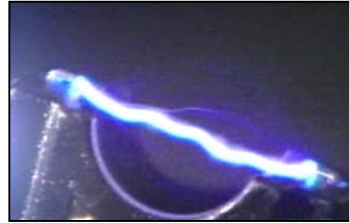

**This exercise will be performed WITHOUT a CARTRIDGE
WITH or WITHOUT A CARTRIDGE the X26E will "FIRE" its
electrical energy if the safety is off and the trigger is pulled,
it will cycle, spark and expose YOU to unintended Electro-
Muscular Disruption and/or Stun Effect IF YOU DO NOT
HANDLE IT PROPERLY - KEEP HANDS, FINGERS & ANY
OTHER PARTS OF YOUR BODY AWAY FROM THE
CONTACTS WHEN THE SAFETY IS OFF OR WHEN THE
X26E IS DISCHARGING**



PRACTICAL EXERCISE - II

Perform a Functions Check on X26E

- (1) Ensure that the safety switch is in the down (SAFE) position
- (2) Remove the air cartridge, if present
- (3) Point the X26E in a safe direction and place the safety switch in the up (FIRE) position
- (4) Check the remaining battery life percentage on the CID
Replace the DPM if the percentage is less than 20%
- (5) Pull the trigger and perform a spark test for one second
- (6) Look for visible spark between the electrodes and listen for a rapid spark rate.
- (7) Place the safety switch in the down (SAFE) position.
- (8) Replace the air cartridge.
- (9) If the functions check is not satisfactory, insert a new DPM and repeat the functions check. If the spark test is still not satisfactory, do not use a malfunctioning X26E



Load and Unload X26E



Load and Unload X26E

- **Standard Weapons Handling Safety**
- **Key areas:**
 - Always place safety switch in the down (SAFE) position
 - Keep fingers clear from blast doors
 - Don't palm the cartridge while loading or unloading it
 - Point weapon in safe direction
 - Keep finger off the trigger



Load and Unload X26E

- To load, an air cartridge and snap it into the front of the unit
- The air cartridge has been specifically designed so there is no “up” or “down” position



**FINGER OFF
TRIGGER**

**SAFETY ON
(DOWN)**

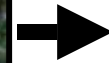
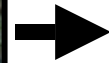

Load X26E

- **Safety Switch Down (SAFE)**
- **Keep fingers clear from blast doors**
- **Point weapon in safe direction**
- **Keep finger off the trigger**





Unload X26E

- **Safety Switch Down (SAFE)**
- **Keep fingers clear from blast doors**
- **Point weapon in safe direction**
- **Keep finger off the trigger**
- **Press Buttons on Cartridge**





CAUTION - WARNING

Load and Unload X26E

**This exercise be will performed with
EXPENDED CARTRIDGES ONLY.**

**WITH or WITHOUT EXPENDED CARTRIDGES the X26E will
"FIRE" its electrical energy if the safety is off and the trigger
is pulled, it will cycle, spark and expose YOU to unintended
Electro-Muscular Disruption and/or Stun Effect IF YOU DO
NOT HANDLE IT PROPERLY - KEEP HANDS, FINGERS &
ANY OTHER PARTS OF YOUR BODY AWAY FROM THE
CONTACTS/CARTRIDGE WHEN THE SAFETY IS OFF OR
WHEN THE X26E IS DISCHARGING**

Load and Unload X26E

WHEN THE X26E IS LOADED WITH AN AIR CARTRIDGE, IT IS A "LIVE" WEAPON. TREAT IT AS A LOADED FIREARM. DO NOT ALLOW OR TOLERATE OTHER SERVICEMEMBERS TO BE COMPLACENT WITH REGARDS TO SAFETY JUST BECAUSE IT IS NOT A CONVENTIONAL FIREARM. DO NOT POINT IT AT OTHERS UNLESS INTENDING TO FIRE

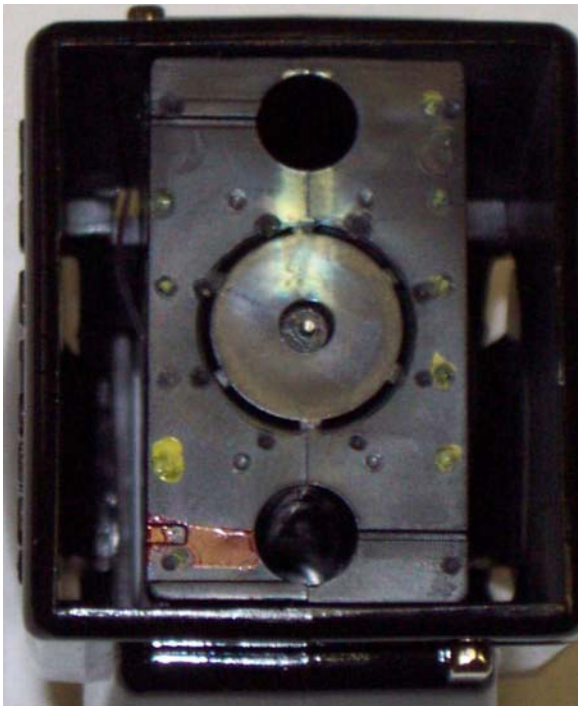

EXPENDED AIR CARTRIDGE
No Blast Doors/Probes/Wires

During PRACTICE
ensure the air
cartridges used
are
EXPENDED!

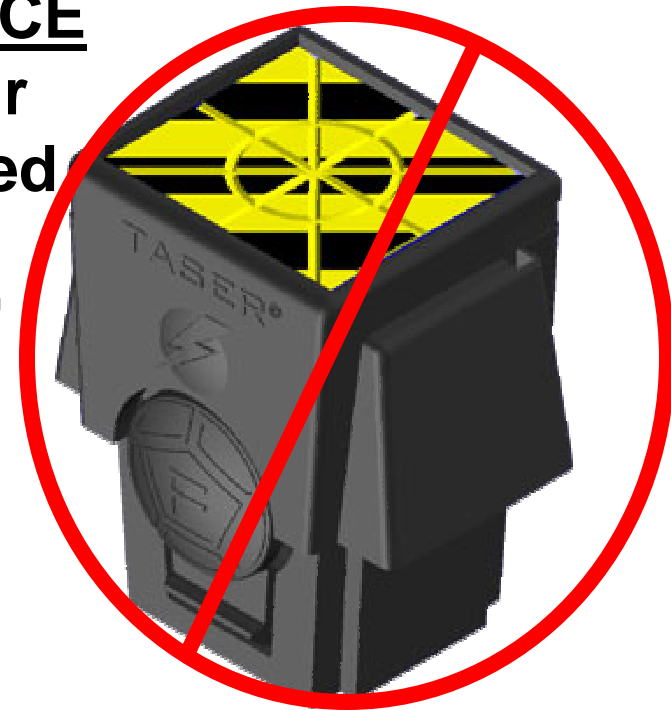

Blast Doors Present



Load and Unload X26E

This is an x-ray of an X26E operator's hand who had place his hand in front of the air cartridge when he pulled the trigger.





PRACTICAL EXERCISE - III Load and Unload X26E

- **Treat this as a loaded weapon**
- **Key areas:**
 - Always place safety switch in the down (SAFE) position
 - Keep fingers clear from blast doors
 - Don't palm the cartridge while loading or unloading it
 - Point weapon in safe direction
 - Keep finger off the trigger



Preventive Maintenance, Checks and Services (PMCS)

Preventive Maintenance, Checks and Services DROPPED or WET X26E

- Safety switch down (SAFE)
- Remove cartridge
- Dry X26E thoroughly
- Safety switch up (ARMED)
 - If X26E discharges without pulling the trigger, remove DPM and return to supply
- Functions Check – spark for full 5 seconds
- If X26E does not function properly, return it to supply – do not use it
- If Functions Check is normal, return to service

CAUTION - WARNING

If the X26E has been dropped or otherwise damaged, or if an X26E is exposed to significant moisture, do not move the safety switch to the up (ARMED) position until after conducting the following check. Failure to perform this check may result in an unintentional discharge when the X26E safety switch is placed in the up (ARMED) position. X26Es exposed to extreme moisture have discharged with the safety switch still in the down (SAFE) position due to short circuiting of the electronic components.

X26E DROPPED

- OTHERWISE DAMAGED - SIGNIFICANT MOISTURE -

- (1) Remove the Air Cartridge immediately
- (2) If exposed to moisture, dry the weapon thoroughly (at least 24 hours) before proceeding
- (3) Remove DPM from the weapon
- (4) Wipe off all exposed surfaces
- (5) If there is any visible moisture inside the DPM well of the X26E, return to supply. If no moisture is visible, re-insert the DPM and complete the remaining steps.
- (6) Wait one minute before proceeding to the next step.
- (7) Place the Safety switch in the up (ARMED) position.
- (8) If the X26E discharges without pulling the trigger, place the safety switch in the down (SAFE) position, remove the DPM and return to supply, do not use it.

X26E DROPPED
- OTHERWISE DAMAGED - SIGNIFICANT MOISTURE -
continued

(9) If the X26E does not discharge without pulling the trigger, conduct a spark test for a full 5-second cycle and ensure a rapid pulse rate and that the discharge stops after five seconds.

(10) If the X26E does not operate normally, place the safety switch in the down (SAFE) position, remove the DPM, and return it to supply.

(11) If the X26E does function normally, place the safety switch in the down (SAFE) position and return to normal use.

In addition to the above test, a thorough inspection of a X26E after being dropped is required. Check the entire X26E for cracks, broken CID, cracked laser/flashlight lens, etc.

DO NOT use an X26E that shows obvious signs of damage



Preventive Maintenance, Checks and Services

- **Avoid dropping - sensitive, electronic device - similar care of a cell phone**
- **Check DPM regularly**
- **Always store X26E with DPM inserted**
- **Check expiration of air cartridges**
- **Secure in protective holster, when not in use**
- **Do not store in pockets without holster**
- **Do not let X26E get excessively wet**

Preventive Maintenance, Checks and Services

Occasionally wipe out the air cartridge firing bay with dry cloth. Multiple cartridge firings create carbon build-up (particularly after training courses)

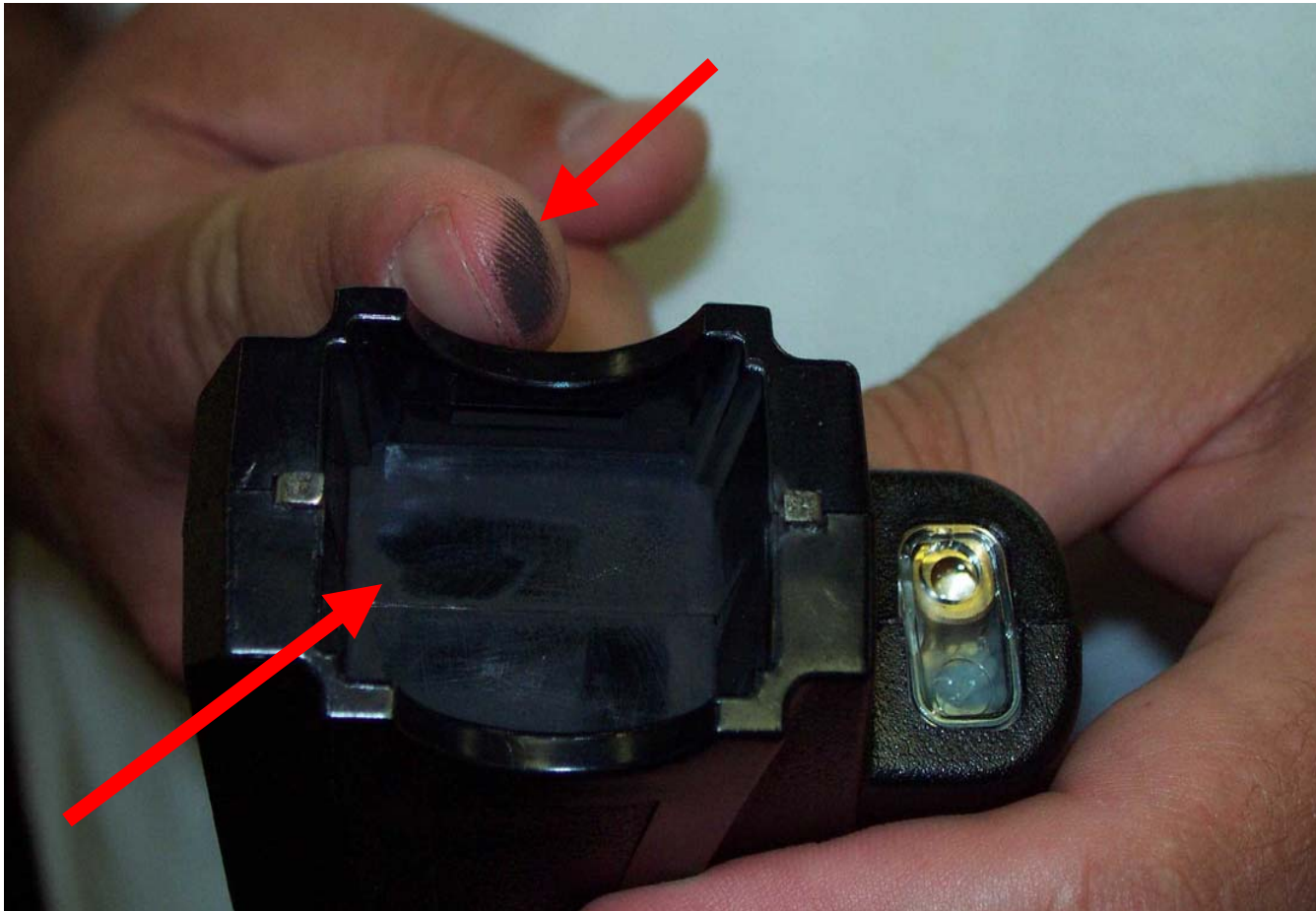



DPM Replacement

- Replace DPM when % life < 20%
- Use for training until 1% remaining
- Dispose at 0%
 - Caution: Continued use at 0% could cause damage to the weapon



1. Safety Switch down
2. Remove Air Cartridge
3. Depress DPM release
4. Remove & replace DPM



DPM Replacement

- When a DPM is replaced with a new DPM that contains a newer update of software than the current version in the X26E, an upgrade programming will occur
- A “P” will be displayed in the CID during the upgrade programming
- After upgrade programming has been completed, the unit will start the boot up sequence
- Removal of the DPM during the "P" state (programming) **WILL** corrupt the software. If this occurs, an “E” or “H” will be displayed. The X26E must then be returned to the factory to be reprogrammed



**State
applicable law,
Service policy, regulation,
order, instruction or
directive regarding the
use and employment of
X26E**



"Legalities"

The X26E was fielded under an urgent need, Rapid Fielding Initiative

For Coalition Forces Land Component Command (CFLCC), CJTF-7, CTF-180 and 3/2 Stryker Brigade and others in the primary theaters of overseas operations

All necessary and required procedures to field it were accomplished (medical review, human effects review, legal review and safety release)

It is not TYPE-CLASSIFIED (official, accepted equipment), BUT it is approved for use IN THEATER



"Legalities"

From: DA ARMY STAFF, PROVOST MARSHAL GENERAL
Sent: Thursday, May 26, 2005 1:52 PM
Subject: PROHIBITION ON USE OF TASER PRODUCTS

UNCLASSIFIED//

1. THIS MESSAGE PROHIBITS THE USE OF TASER DEVICES BY MILITARY AND DEPARTMENT OF THE ARMY CIVILIAN POLICE AS PART OF LAW ENFORCEMENT PROCEDURES ON ARMY INSTALLATIONS.
2. PROVISIONS OF REF A REQUIRE THE DEVELOPMENT AND IMPLEMENTATION OF EMPLOYMENT CONCEPTS THAT INCLUDE TACTICS, TRAINING, AND SECURITY PROCEDURES. TO FULLY IMPLEMENT THESE REQUIREMENTS, DEPARTMENT OF THE ARMY POLICY MUST BE DEVELOPED, COORDINATED, AND RECEIVE APPROVAL.



"Legalities"

From: DA ARMY STAFF, PROVOST MARSHAL GENERAL
Sent: Thursday, May 26, 2005 1:52 PM
Subject: PROHIBITION ON USE OF TASER PRODUCTS

POLICY DEVELOPMENT IS UNDERWAY IN COORDINATION WITH THE U.S. ARMY MILITARY POLICE SCHOOL, ARMY STAFF OFFICES, THE OTHER ARMED SERVICES, AND THE DEPARTMENT OF DEFENSE. PENDING FURTHER REVIEW AND DEVELOPMENT OF IMPLEMENTING POLICY ON TASERS, THEIR USE ON ARMY INSTALLATIONS FOR GARRISON LAW ENFORCEMENT DUTIES IS PROHIBITED AND NO WAIVERS WILL BE GRANTED.

3. POINTS OF CONTACT ARE MR JEFFERY PORTER, (703) 695-8823, DSN 225-8823 OR MR JAMES CRUMLEY (703) 692-6721, DSN 222-6721.



Where laws specifically address X26E or like technology

Source:
Douglas E. Klint,
General Counsel
TI, Inc.
May 2004

"Legalities"

STATE	LE USE	CONSUMER USE
Connecticut	Legal	Legal for home use
Florida	Legal	Legal, restrictions
Hawaii	Legal	Prohibited
Illinois	Legal	Legal, restrictions
Indiana	Legal	Legal, restrictions
Massachusetts	Prohibited	Prohibited
Michigan	Legal	Prohibited
New Jersey	Prohibited	Prohibited
New York	Legal	Prohibited
North Carolina	Legal	Legal, restrictions
North Dakota	Legal	Legal, restrictions
Rhode Island	Legal	Prohibited
Washington	Legal	Legal, restrictions
Wisconsin	Legal	Prohibited

INIWIC COURSE – NOT FOR USER / UNIT TRAINING



"Legalities"

CITY OR COUNTY	LE USE	CONSUMER USE
Annapolis	Legal	Prohibited
Baltimore	Legal	Prohibited
Chicago	Legal	Prohibited
Howard County, MD	Legal	Prohibited
Lynn County, OH	Legal	Legal, with restrictions
New York City	Legal	Prohibited
Philadelphia	Legal	Prohibited
Washington, D.C.	Legal	Prohibited

Where laws specifically address X26E or like technology

Source: Douglas E. Klint, General Counsel, TI, Inc., May 2004



"Legalities"

The status of State law (law enforcement approved, prohibited, or not addressed) is **NOT** an automatic approval or prohibition for National Guard use when in SAD status.

Before X26E training ever begins ensure coordination has been made with and through the State Chain-of-Command; You and the unit Commander should have in hand a document signed by Competent State Military Authority that the X26E is APPROVED for training and use while under State Authority / Control.

The Commander has to want it, SJA must provide legal review, State law must permit it.



"Legalities"

INIWIC has no knowledge of any individual State law or policy regarding the use of the X26E by the States' National Guard.

INIWIC has no knowledge nor has it received any guidance regarding the use of the X26E domestically, by U.S. Forces (active duty or federalized), except for the previous recent Army message prohibiting its use in law enforcement operations on Army installations.



"Legalities"

YOUR DUTY and RESPONSIBILITY as the unit nonlethal weapons instructor / advisor is to determine the legality of the X26E within the context of the unit's mission - this is accomplished through the Chain-of-Command.

Legality is a critical issue. The Command's desire to train and employ the X26E is critical as well. It is a Command's prerogative NOT to utilize a particular nonlethal even when it is legal or authorized.



State applicable law, Service policy, regulation, order, instruction or directive regarding the use and employment of X26E

- You must incorporate the above ELO (task) into your X26E training with the correct information that corresponds to the unit's situation. What does the user need to know?
- OIF Pre-Deployment training versus Domestic Support Opns versus a State Civil Authorities Support Opns
- This includes Rules of Engagement / Rules for Use of Force that apply to the use of the X26E



Download X26E usage data (Unit SOP dependent)



Download X26E usage data (Unit SOP dependent)



- X26E USB Dataport
 - Time, date, duration, temp, battery status of each firing (over 1,500)
 - Connection protected inside DPM slot
 - Encrypted data files
 - Date range downloads
 - USB plug & play

Download X26E usage data (Unit SOP dependent)



X26 Operational Records

X26 DATAPORT DOWNLOAD

SERIAL NUMBER OF X26: X00-000410 MODEL #: X26

DATE OF DOWNLOAD: 09/08/03 19:10:29

LOCAL TIMES CALCULATED FOR: GMT - 07:00, Mountain Standard Time (Arizona)

DATA RANGE DOWNLOADED: All Data

RECORDED FIRING DATA

GMT TIME	Local Time	Duration [Secs]	Temperature [deg. C]	Battery [%]
09/09/03 01:23:12	09/08/03 18:23:12	1	30	96
09/09/03 01:23:15	09/08/03 18:23:15	1	31	96

TIME CHANGE RECORD

The log below shows the time and dates that the internal clock of the X26 has been reset.

GMT TIME	Local Time	Change Type
09/09/03 01:21:01	09/08/03 18:21:01	TO

Zoom Out Print Save As Encrypted Log Exit

DEVICE FIRE RECORDS

GMT TIME	Local Time	Duration [Secs]	Temperature [deg. C]	Batt [%]
09/09/03 01:23:12	09/08/03 18:23:12	1	30	96
09/09/03 01:23:15	09/08/03 18:23:15	1	31	96
09/09/03 01:23:20	09/08/03 18:23:20	5	31	96
09/09/03 01:23:31	09/08/03 18:23:31	10	32	96
09/08/03 19:44:29	09/08/03 12:44:29	1	31	95
09/08/03 19:44:31	09/08/03 12:44:31	2	31	95
09/08/03 19:44:36	09/08/03 12:44:36	5	31	95
09/08/03 19:44:50	09/08/03 12:44:50	12	32	95

Fire records found: 8

Download X26E usage data (Unit SOP dependent)

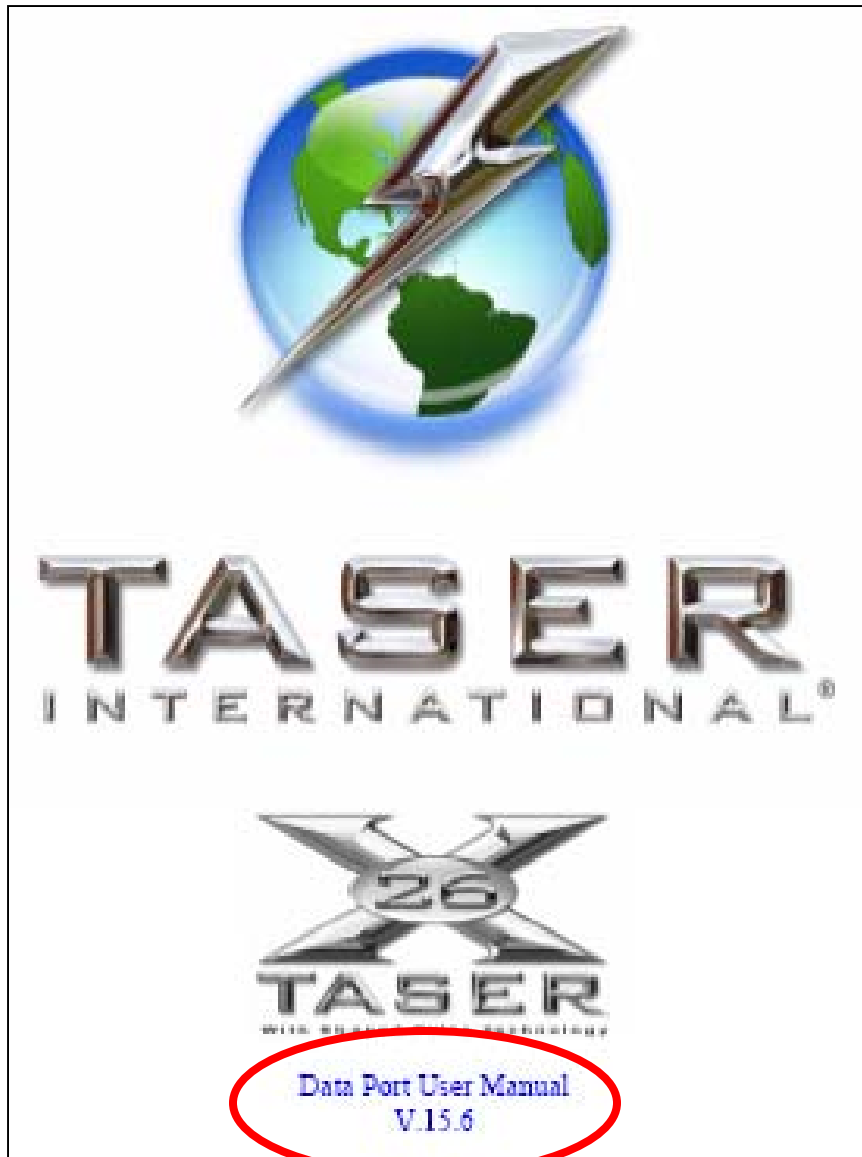

Follow step by step instructions in the latest Data Port User Manual (V.15.6)

Administrator Privileges are usually required on U.S. military computers to install the download software

The computer must have a USB port

Check www.taser.com for updates



Engage targets with X26E



Engage targets with X26E

- Aim like a standard firearm at center of mass
- Use sights and/or laser
- Observe standard sidearm safety guidelines
- Probe Ballistics:
 Rule of Thumb: 1 foot (.3m) spread between probes for every 7 feet (2.1m) of travel.

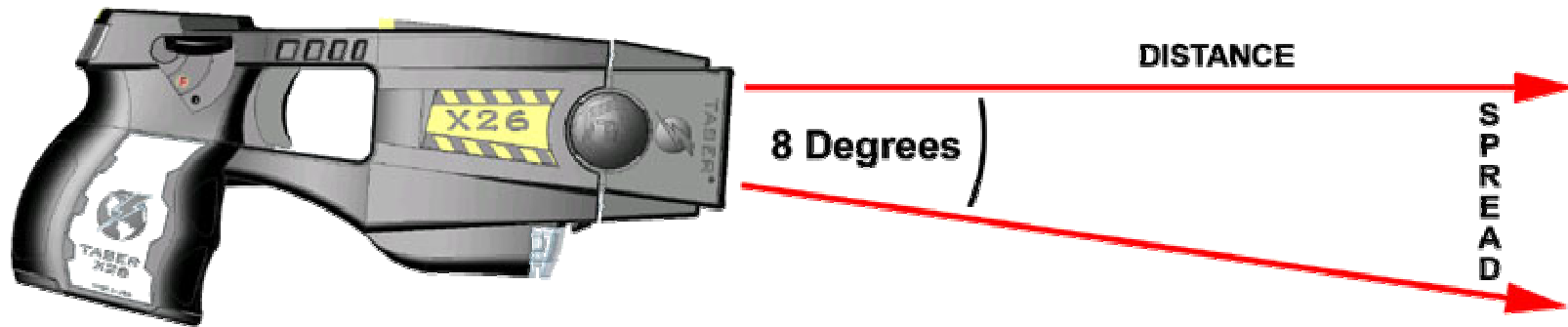

	(m)	.6	1.5m	2.1m	3m	4.5m	6.4m	7.6m
Target Distance	(ft)	2'	5'	7'	10'	15'	21'	25'
Spread	(in)	4"	9"	13"	18"	26"	36"	38"
	(cm)	10cm	23cm	33cm	46cm	66cm	91cm	109cm



Engage targets with X26E

When fired, the top probe impacts at point of aim. The laser indicates the point of impact within 3 inches at a distance of 13 feet.

The bottom dart travels at an 8-degree angle downward. The spread between probes increases the further you get from your target with the probes separating one foot (.3m) for every 7 feet (2.1m) they travel.

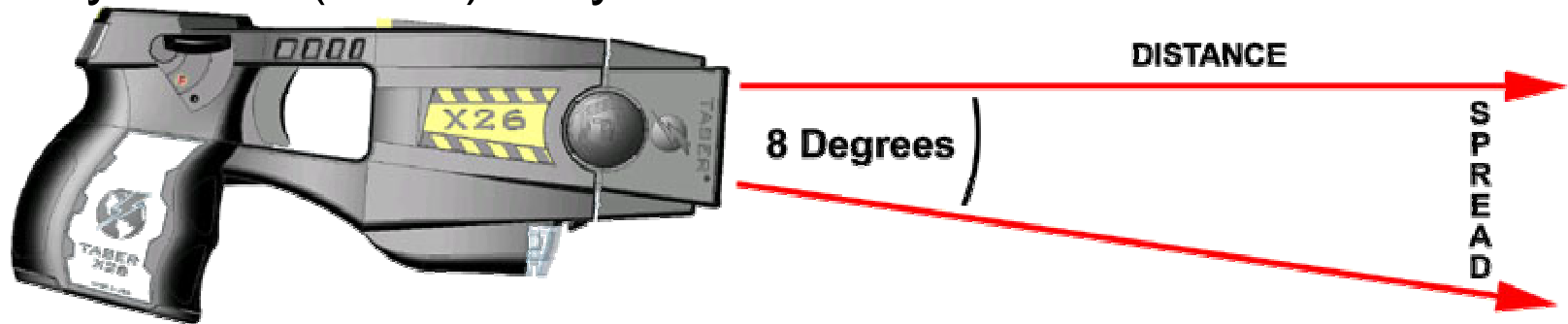



Engage targets with X26E

- Aim at target: Center of mass or legs
- Laser is point of impact for top dart within 3 inches at 13 feet
- X26E fires probes in line with 8-degree probe spread
- Hold upright for vertical target

HOLD LEVEL



DO NOT TILT





Engage targets with X26E

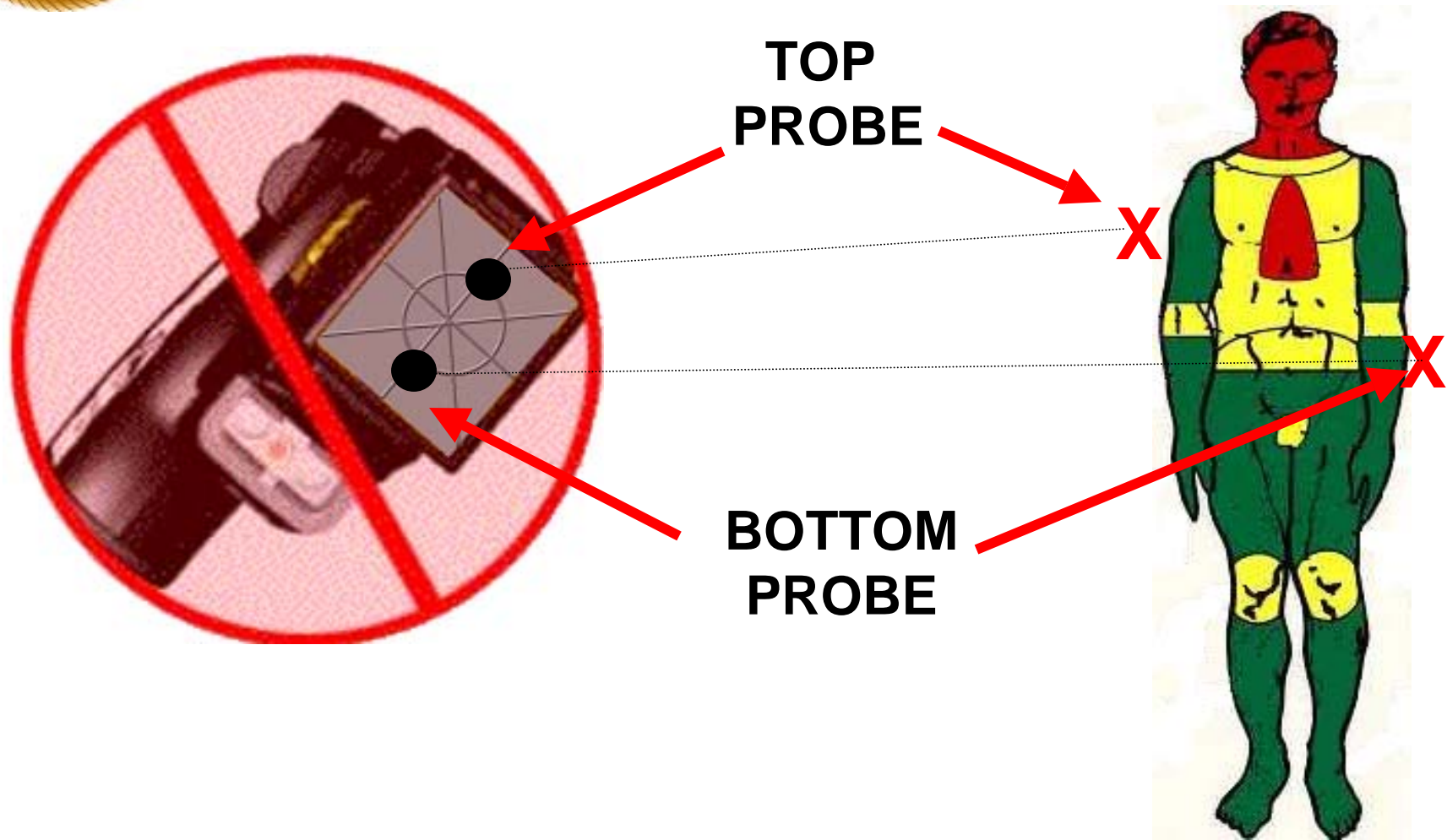



Engage targets with X26E

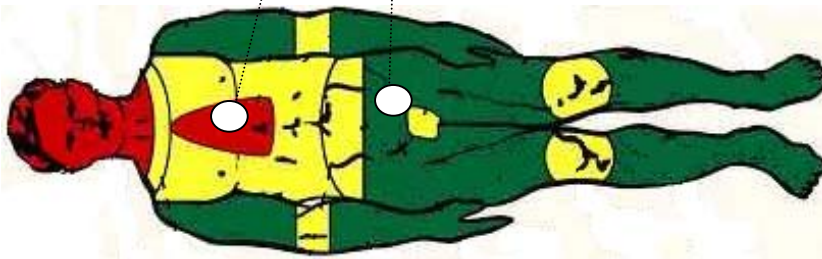
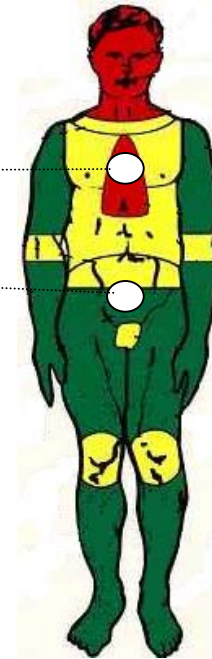
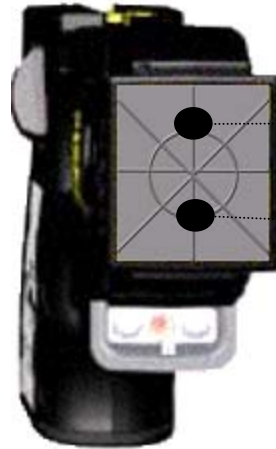

- Weapon Orientation
- Same Parallel Plane
- Point of Aim / Top Probe

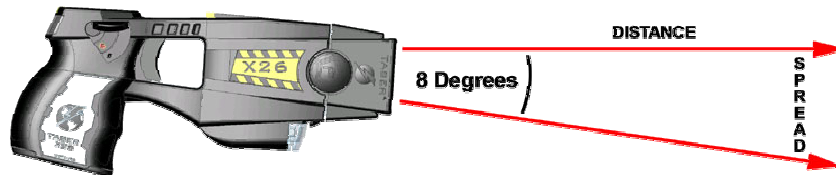



Engage targets with X26E

- Effective from point blank to 21 or 25 feet
- Optimum range = 7 to 15 ft from target for probe spread, Servicemember safety and accuracy
- Greater probe spread increases effectiveness
 - If possible, minimum 4 inch spread
- If possible, fire X26E at subject's back:
 - Clothing fits tighter
 - Surprise factor
 - Stronger muscles -- even more overwhelming
- Avoid face, throat or groin exposure if possible



Engage targets with X26E

MISFIRE

If the cartridge does not fire it may fire after a delay

Even though the cartridge did not fire during the first pulse, there are 15-20 pulses per second, and any of these pulses may discharge the cartridge

Make sure that the weapon is aimed at the intended target until the weapon is put in SAFE mode. If you aim the weapon off target while the X26E is still cycling, it could discharge the cartridge and hit an unintended target

Engage targets with X26E

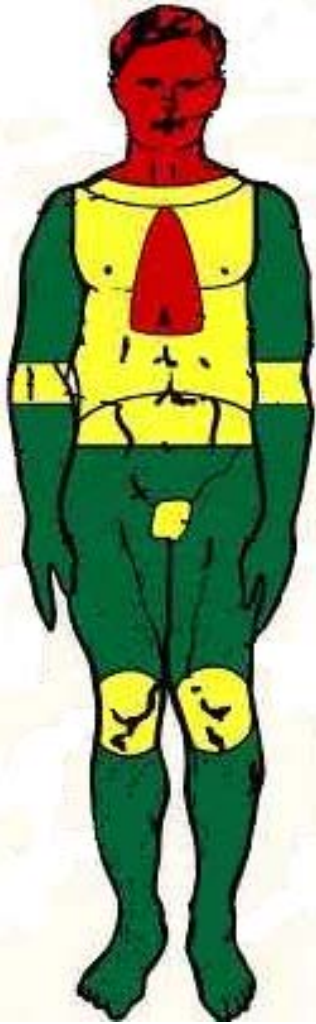

**BLUNT
IMPACT**



**X26E Application
Avoid Head/Throat/Groin**



**OC
Application**



Engage targets with X26E

Probe Removal

BEFORE training and employment of X26E, local command policy or SOP MUST BE developed, trained and practiced Regarding X26E follow on or follow up actions, which includes Probe removal. The blood-borne pathogen risks and mitigation procedures must be addressed.

A method to remove the probe from tissue is to stabilize the flesh with one hand, firmly and quickly pull the probe free. Make sure that the stabilizing hand is at least several inches away from the probe impact site.

INIWIC COURSE – NOT FOR USER / UNIT TRAINING



Engage targets with X26E

Drive Stun Application

- The X26E will always fire a live cartridge when activated if an unfired cartridge is present
- Upon the firing of the cartridge, the X26 is capable of functioning in the stun mode immediately as backup weapon without having to remove the fired cartridge
- To use drive stun without firing probes, remove live cartridge
- The drive stun mode affects the sensory nervous system ONLY making it a pain compliance weapon that will not cause EMD



Engage targets with X26E

Drive Stun Application

- If not effective, evaluate location of drive stun and change target of opportunity to pressure points or consider alternative force options.
- A drive stun with a live cartridge is possible. However, the probes will fire into the subject
- There is no over penetration
- Cartridge might not deploy when in direct contact with subject, but will still have drive stun effect



Engage targets with X26E

Drive Stun Application

- Probes can help maintain contact with a violent subject
- You can then apply a drive stun away from probes to achieve EMD
- **Do not** hold on to live cartridge while applying a drive stun
- If cartridge gets within 2 inches of X26E or subject it may deploy



Engage targets with X26E

Drive Stun Application

Aggressively DRIVE X26E into target areas while pulling the trigger, into the CENTER OF MASS of LARGE MUSCLE MASS

- Shoulder-Chest
- Forearm
- Thigh
- Calf

Avoid Head/Neck/Throat/Groin

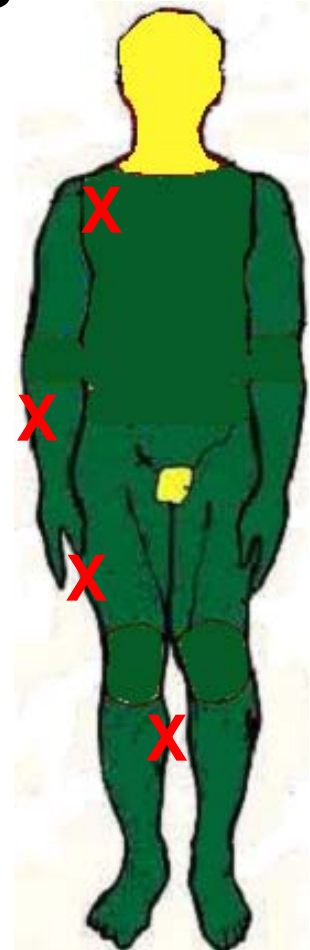

Drive Stun Scarring





Engage targets with X26E **HOLSTER ORIENTATION**

Holster - Release – Draw – Holster Familiarization

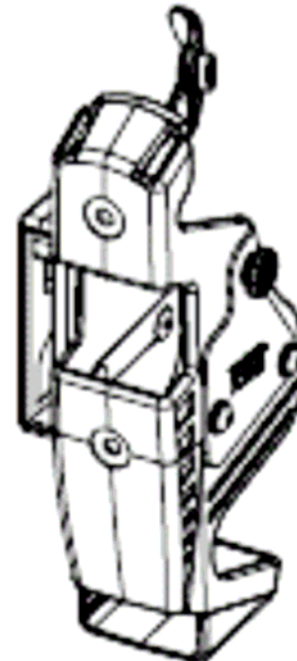
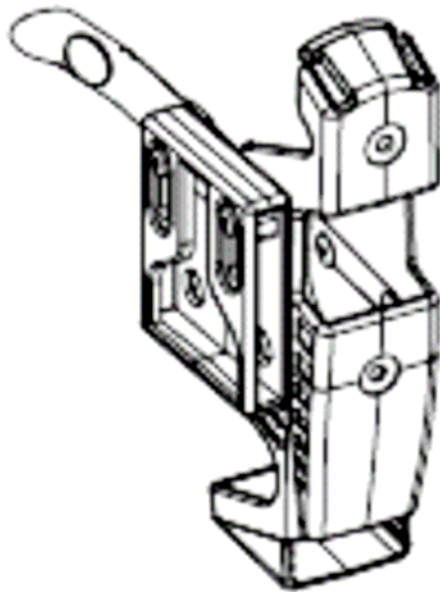
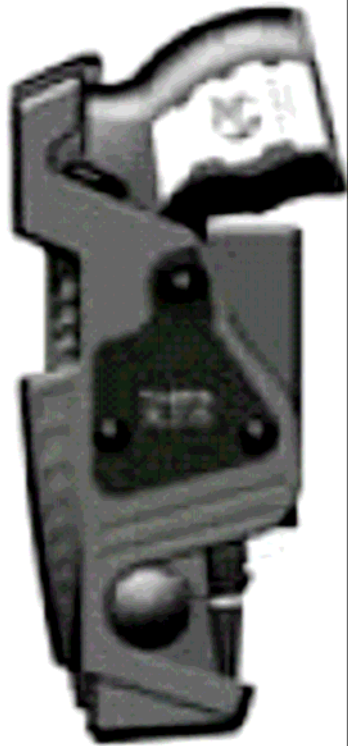



X26E

**TACTICS, TECHNIQUES
PROCEDURES
Unit SOP Considerations**

INIWIC COURSE – NOT FOR USER / UNIT TRAINING



X26E TTP

Unit SOP Considerations

- Effective tactics to ensure the subject is safely subdued and quickly restrained is CRITICAL. Empty hand, open hand, manual subject control techniques (joint locks, restraint techniques, tactical cuffing techniques) are absolutely REQUIRED for the issue and use of the X26E
- Aside from the intimidation factor an X26E may possess, it is only effective during its delivery of energy into the subject. Once the energy delivery ceases, the subject may instantly become resistive/assaultive. The subject must be restrained quickly and efficiently



X26E TTP

Unit SOP Considerations

What Could Go Wrong

- Consider the fact that if a unit has X26Es and does not train and qualify Servicemembers on them, then the first thing that could go wrong, just went wrong.
- Not having thorough and complete drill, SOP or well-rehearsed tactical plan for the X26E's use
- Could ignite gas fumes, some aerosol chemical agents or other flammable or combustibles

INIWIC COURSE – NOT FOR USER / UNIT TRAINING



X26E TTP

Unit SOP Considerations

What Could Go Wrong

- “Silence is Golden”. The X26E’s electrical current is relatively quiet in actual human use. Practice targets are loud since the energy is arcing in the air. If electrical current is loud during field hit and the subject is not reacting, the energy is most likely shorting out and may not be effective
- The Servicemember with the X26E could miss (reload)



X26E TTP

Unit SOP Considerations

What Could Go Wrong

The X26E could be abused. It could be unlawfully utilized against a subject that is clearly not a threat or under circumstances that would bring discredit to the U.S. military and the United States; causing a prohibition to be imposed against utilizing this nonlethal technology, all together. Guard against such abuses, not matter what the circumstances



X26E TTP

Unit SOP Considerations

What Could Go Wrong

MISFIRE

If the cartridge does not fire it may fire after a delay

Even though the cartridge did not fire during the first pulse, there are 15-20 pulses per second, and any of these pulses may discharge the cartridge

Make sure that the weapon is aimed at the intended target until the weapon is put in SAFE mode. If you aim the weapon off target while the X26E is still cycling, it could discharge the cartridge and hit an unintended target

INIWIC COURSE – NOT FOR USER / UNIT TRAINING



X26E TTP

Unit SOP Considerations

- **A full 5-second cycle deployment should be applied without interruption (unless circumstances dictate otherwise)**
- **Each 5-second cycle is a “window of opportunity” for the team to apprehend the subject and go hands on. Remember electricity does not linger in the body.**



X26E TTP

Unit SOP Considerations

Window of opportunity Servicemembers can go hands on with out fear of being incapacitated by touching a subject undergoing the 5-second cycle

X26E operator should be prepared to apply additional cycles if necessary

Subject is only incapacitated during the cycle - the window of opportunity – subject can recover immediately

Servicemembers should provide verbal commands before, during and after application

INIWIC COURSE – NOT FOR USER / UNIT TRAINING



X26E TTP

Unit SOP Considerations

Servicemembers can subdue and cuff without hesitation during the cycle. Do not touch or step on probes or wires

X26E operator, should give verbal commands to the subject during the cycle. Many people can hear and comprehend directions during the X26E cycle

Communication between Servicemembers

Servicemembers who don't carry X26Es should be trained so they know they can take subjects into custody during the X26E cycle without fear



X26E TTP

Unit SOP Considerations

Nothing is ever 100% effective - do not become “X26E dependent”

The X26E is not a stand-alone force option. Follow-on tactics and techniques are required.

The unpredictability of tactical situations require the instant ability to respond across the force continuum

Use COVER AND DISTANCE to ensure Servicemember safety

INIWIC COURSE – NOT FOR USER / UNIT TRAINING



X26E TTP

Unit SOP Considerations

Wires are lightly insulated and can break easily if stepped or fallen upon, or if a running target is hit without allowing for extra slack

Use a code word like, “26! 26!” prior to deployment to prevent sympathetic firing from others

If appropriate, allow display of arc or laser to gain compliance

If first shot fails/misses: cover, reload or resort to another tactic; subject charges, move, aggressively “drive-stun” or change force options

INIWIC COURSE – NOT FOR USER / UNIT TRAINING



It is the responsibility of the INIWIC unit instructor to develop, write, seek approval for, and train unit SOPs for the X26E

- Who or what position will be issued an X26E?
- Security, storage, accountability, issue (arms room?)
- How carried and where?
- Basic Load - how many air cartridges per operator?
- X26E firing / warning code word? Probe Removal?
- Documenting training - initial and sustainment
- Reporting X26E use
- When / How often to download?
- Who downloads? Where will the records be kept?
- **A COMPLETE & COMPREHENSIVE SOP MUST BE COMPLETED & FINALIZED PRIOR TO TRAINING**

INIWIC COURSE – NOT FOR USER / UNIT TRAINING



It is the responsibility of the INIWIC unit instructor to develop, write, seek approval for, and train unit SOPs for the X26E

Unit SOP must cover the tactics, techniques and procedures for the employment of the X26E within the context of the unit's MISSIONS and TASKS

Training the X26E is only a portion of the responsibility and duty YOU have...

A COMPLETE & COMPREHENSIVE SOP MUST BE COMPLETED & FINALIZED PRIOR TO TRAINING, SO IT CAN BE INCLUDED IN UNIT TRAINING!

INIWIC COURSE – NOT FOR USER / UNIT TRAINING



PRACTICAL EXERCISES PERFORMANCE EVALUATION QUALIFICATION

INIWIC COURSE – NOT FOR USER / UNIT TRAINING



PRACTICAL EXERCISES PERFORMANCE EVALUATION QUALIFICATION

Practical Exercises. Have the Servicemembers practice the practical exercises. Provide the necessary demonstration, assistance and explanation.

PE #1. Loading Cartridges. Objective: To familiarize students with proper loading techniques, considering tactics and safety.

PE #2. Spark Drill. Objective: To provide each student the practical training to safely and properly operate the safety switch and trigger on the X26E.

INIWIC COURSE – NOT FOR USER / UNIT TRAINING



PRACTICAL EXERCISES PERFORMANCE EVALUATION QUALIFICATION

PE #3. Aiming. Objective: Provide adequate practice to familiarize the students with the use of the safety switch, laser sight, and verbal commands.

PE #4. Live Fire. Objectives: To become familiar with the sight, sound and feel of an air cartridge being deployed. To be able to put both probes on a target. To become accustomed to using the fixed sights and laser sight.



PRACTICAL EXERCISES PERFORMANCE EVALUATION QUALIFICATION

PE #5: Reloading. Objectives: Provide adequate practice to reload air cartridges while remaining focused on the subject. Increase muscle memory to facilitate reloading under stress.

PE #6: Sighted Firing. Objectives: To fire the X26E with high visibility sights only (no laser). To learn proper drive stun follow up tactics.

PE #7: Drive Stun. Objectives. To learn proper drive stun techniques.

INIWIC COURSE – NOT FOR USER / UNIT TRAINING



PRACTICAL EXERCISES PERFORMANCE EVALUATION QUALIFICATION

PE #8: Misfire. Objectives: Provide adequate practice for immediate action, when the weapon misfires. Provide an opportunity to consider transition to another appropriate force option; reload or drive stun or create distance.



X26E Training and Qualification Record

PERFORMANCE EVALUATION - GO / NO GO

PE #1. Loading Cartridges	GO	NO	GO
PE #2. Spark Drill	GO	NO	GO
PE #3. Aiming	GO	NO	GO
PE #4. Live Fire	GO	NO	GO
PE #5: Reloading	GO	NO	GO
PE #6: Sighted Firing	GO	NO	GO
PE #7: Misfire	GO	NO	GO
PE #8: Drive Stun	GO	NO	GO

INIWIC COURSE - NOT FOR USER / UNIT TRAINING



X26E Training and Qualification Record

8 "Stations" or Points In Sequence

#1
Loading
Cartridges

#2
Spark
Drill

#3
Aiming

#4
Live
Fire

#5
Reloading

#6
Sighted Firing

#7
Misfire

#8
Drive Stun

QUAL

= Expended / Inert Cartridge

= Unexpended / Live Cartridge

INIWIC COURSE – NOT FOR USER / UNIT TRAINING



X26E Training and Qualification Record

8 "Stations" or Points In Sequence

#1
Loading
Cartridges

EXPENDED
INERT

#2
Spark
Drill

UNLOADED

#3
Aiming

LOAD
LIVE

#4
Live
Fire

FIRE
LIVE

#5
Reloading

LOAD
LIVE

#6
Sighted Firing

FIRE
LIVE



#7
Misfire

UNLOADED

#8
Drive Stun

QUAL

FIRE LIVE

  = Unexpended / Live Cartridge  = Expended / Inert Cartridge / Unloaded

INIWIC COURSE – NOT FOR USER / UNIT TRAINING



X26E Training and Qualification Record



Cardboard



Plywood
Pre-tested



Target Material and Backstop
MUST ALLOW the barb to
penetrate/stick - reliably
Test it first!
Appropriate EYE PROTECTION
ABSOLUTELY REQUIRED

**INIWIC COURSE – NOT
FOR USER / UNIT TRAINING**



X26E Training and Qualification Record

8 "Stations" or Points In Sequence

**#7
Misfire**

**#8
Drive Stun**

UNLOADED

The Misfire - Drive Stun should be performed as a controlled scenario. A role player in protective training suit that prevents the X26E energy from penetrating closes on the X26E operator requiring the X26E operator to employ Drive Stun technique. Otherwise, the X26E operator will Drive Stun an inert target.



X26E Training and Qualification Record

PERFORMANCE EVALUATION	GO	/	NO	GO
PE #1. Loading Cartridges	<u>GO</u>		NO	GO
PE #2. Spark Drill	<u>GO</u>		NO	GO
PE #3. Aiming	<u>GO</u>		NO	GO
PE #4. Live Fire	<u>GO</u>		NO	GO
PE #5: Reloading	<u>GO</u>		NO	GO
PE #6: Sighted Firing	<u>GO</u>		NO	GO
PE #7: Misfire	<u>GO</u>		NO	GO
PE #8: Drive Stun	<u>GO</u>		NO	GO

**REQUIRE ALL Go's Before Qualification
A No Go Requires Re-Training - No Slack,
Maintain Standards, Do Not Allow The Poor Performers
To Qual or Carry - Unit SOP**

INIWIC COURSE – NOT FOR USER / UNIT TRAINING



X26E Training and Qualification Record

QUALIFICATION

1. Engage 4 meter target with X26E
2. Within ten seconds
 - a. engage 2.5 meter target with X26E
 - b. reload
 - c. engage second target at 4 meters with laser sight
3. Optional - Pass written test



X26E Training and Qualification Record

1. Engage 4 meter target with X26E using the open sights

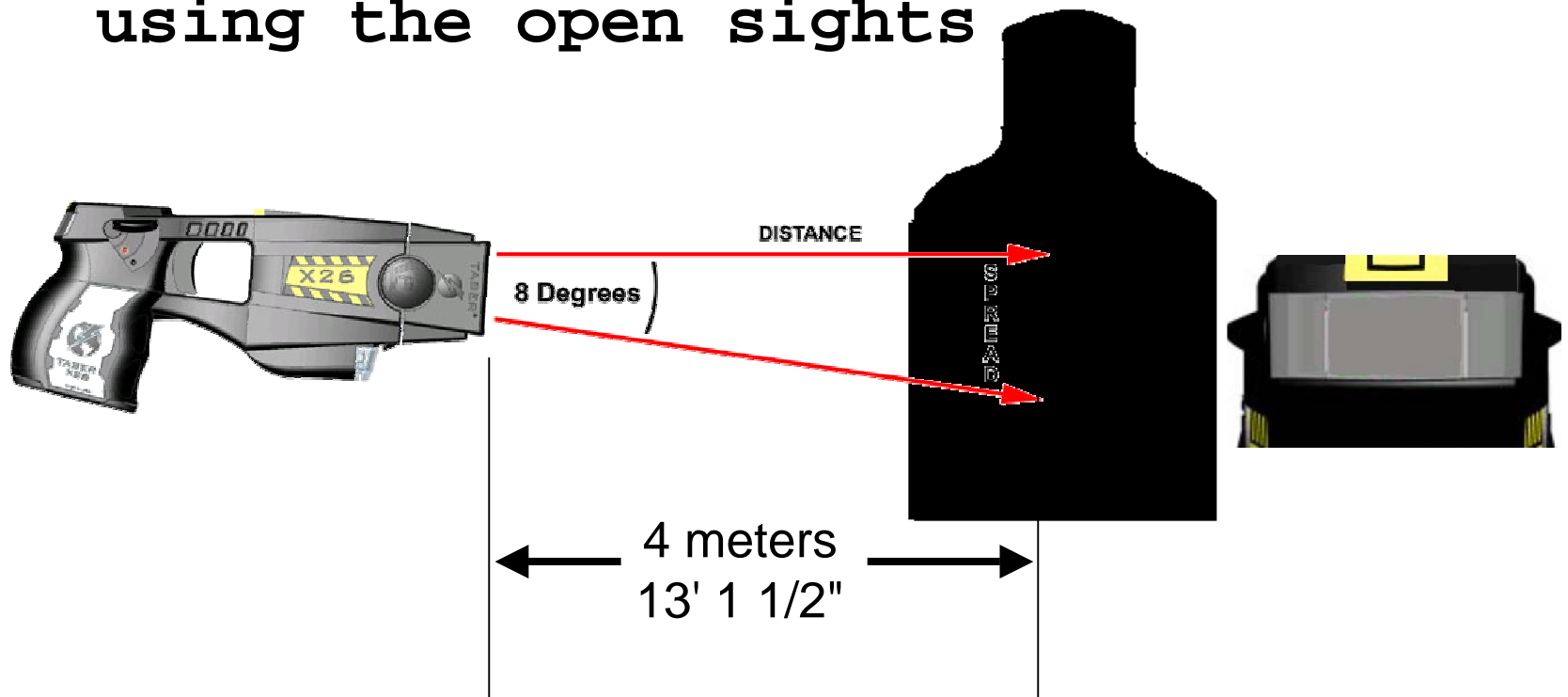

BOTH PROBES MUST STRIKE THE TARGET

INIWIC COURSE – NOT FOR USER / UNIT TRAINING



X26E Training and Qualification Record

2. Within ten seconds
 - a. engage 2.5 meter target
 - b. reload
 - c. engage second target at 4 meters with laser sight

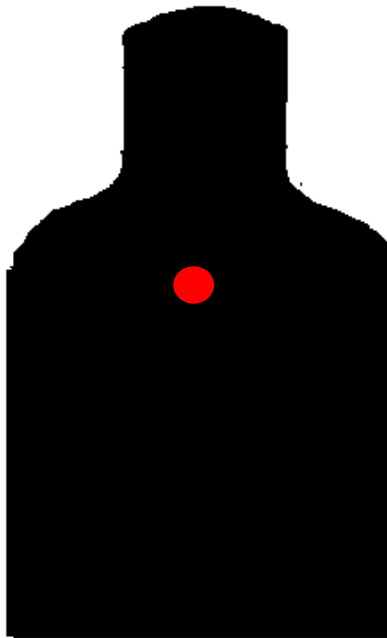

2.5 meters
8' 2"

"Bang" start time
Countdown
Reload
"Bang" stop time

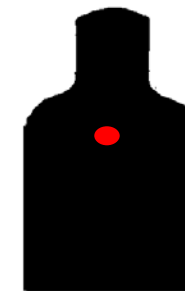

4 meters
13' 1 1/2"

BOTH PROBES MUST STRIKE THE TARGET

INIWIC COURSE – NOT FOR USER / UNIT TRAINING



Minimum Training Standards for the tactical employment of the X26E

You train / impart the required knowledge and skills to your students

1. State the X26E's intended purpose and function as a nonlethal electro-muscular disruption weapon.
2. Identify X26E nomenclature, parts and functions.
3. Identify X26E air cartridges and their characteristics.
4. Perform a functions check on X26E.
5. Load and unload X26E.
6. Conduct Preventive Maintenance, Checks and Services.
7. State applicable law, Service policy, regulation, order, instruction, directive regarding the use and employment of X26E.
8. Download X26E usage data. (Unit SOP dependent)
9. Engage targets with X26E.

INIWIC COURSE – NOT FOR USER / UNIT TRAINING



INIWIC X26E, EMD Instructor

- **Homework Assignments**
 - **Risk Assessment**
 - **Training Plan on How To Train Servicemembers on Judging Engagement Distances for X26E employment, Not a lecture, a PRACTICAL EXERCISE**
- **Download X26E**
- **"Open Book" Written Exam**
- **INIWIC PE and Qualification**



SAFETY BRIEF
PRACTICAL EXERCISES
PERFORMANCE EVALUATION
QUALIFICATION

QUESTIONS